

**This electronic collection of documents is provided
for the convenience of the user
and is Not a Certified Document –**

**The documents contained herein were originally issued
and sealed by the individuals whose names and license
numbers appear on each page, on the dates appearing
with their signature on that page.**

**This file or an individual page
shall not be considered a certified document.**

STATE OF NORTH CAROLINA
 DIVISION OF HIGHWAYS

HENDERSON COUNTY
U-5887

INDEX OF SHEETS

DESCRIPTION	SHEET NO.
INDEX OF SHEETS & CROSS-SECTION SUMMARY	X-1A
-L-	X-1 TO X-38
-Y1-	X-39 TO X-40
-Y2-	X-41
-Y3-	X-42
-Y5-	X-43 TO X-44
-Y6-	X-45
-Y7-	X-46
-PATH2-	X-47 TO X-50

Note: "Quantities are approximate only. The Resident Engineer will re-cross-section the work accurately when the project is staked out. These cross-section notes will be used in computing the final quantities for which the contractor will be paid."

8/17/99

5/7/2020 9:47:07 PM
 \\XCS01\5887\SC\INDEX.dgn
 11:52:10 AM

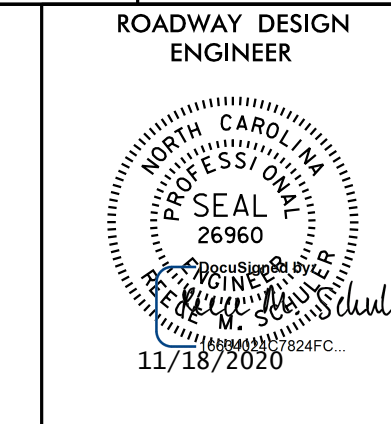

STATE OF NORTH CAROLINA
DIVISION OF HIGHWAYS

HENDERSON COUNTY

U-5887

CROSS-SECTION SUMMARY

Station	Uncl. Exc. (cu. yd.)	Embt (15%) (cu. yd.)
L		
10+00	118	10
10+50	128	28
11+00	20	28
11+50	22	22
12+00	13	24
12+50	8	22
13+00	13	33
13+50	17	36
14+00	20	41
14+50	19	57
15+00	16	31
15+50	22	62
16+00	24	125
16+50	25	114
17+00	26	110
17+50	22	113
18+00	20	119
18+50	20	125
19+00	21	117
19+50	20	105
20+00	21	77
20+50	23	69
21+00	23	98
21+50	20	148
22+00	22	596
22+50	24	594
23+00	28	129
23+50	27	138
24+00	16	241
24+50	23	291
25+00	40	328
25+50	47	366
26+00	52	291
26+50	47	154
27+00	36	91
27+50	28	77
28+00	28	63
28+50	32	67
29+00	24	87
29+50	14	107
30+00	15	112
30+50	17	97
31+00	23	74
31+50	14	58
32+00	7	47
32+50	13	49
33+00	13	48
33+50	14	51
34+00	17	58
34+50	26	51
35+00	32	47
35+50	30	45
36+00	22	44
36+50	19	51
37+00	17	73
37+50	11	94
38+00	15	80
38+50	33	56
39+00	37	42
39+50	28	59

Station	Uncl. Exc. (cu. yd.)	Embt (15%) (cu. yd.)
L		
40+00	13	183
40+50	0	327
41+00	0	371
41+50	0	405
42+00	0	409
42+50	0	283
43+00	12	128
43+50	49	36
44+00	119	4
44+50	108	4
45+00	61	33
45+50	64	83
46+00	45	134
46+50	24	146
47+00	15	128
47+50	11	81
48+00	9	103
48+50	20	102
49+00	37	161
49+50	28	366
50+00	9	3
50+50	2	553
51+00	0	618
51+50	0	539
52+00	0	336
52+50	4	132
53+00	24	33
53+50	33	34
54+00	34	55
54+50	54	40
55+00	58	28
55+50	64	13
56+00	65	10
56+50	40	25
57+00	35	43
57+50	43	35
58+00	24	12
58+50	2	0
59+00	2	0
59+50	21	0
60+00	28	0
60+50	19	0
61+00	1	0
61+50	0	0
62+00	123	0
62+50	28	0
63+00	33	0
63+50	28	0
64+00	12	0
64+50	0	0
65+00	0	0
65+50	0	0
66+00	0	0

Station	Uncl. Exc. (cu. yd.)	Embt (15%) (cu. yd.)
Y1		
13+50	12	0
14+00	12	0
14+50	10	0
15+00	17	0
15+50	24	0
16+00	9	0

Station	Uncl. Exc. (cu. yd.)	Embt (15%) (cu. yd.)
Y2		
10+50	39	8
11+00	23	1

Station	Uncl. Exc. (cu. yd.)	Embt (15%) (cu. yd.)
Y3		
10+50	2	78
11+00	6	13
11+50	4	4

Station	Uncl. Exc. (cu. yd.)	Embt (15%) (cu. yd.)
Y5		
10+50	10	53
11+00	3	52
11+50	0	23

Station	Uncl. Exc. (cu. yd.)	Embt (15%) (cu. yd.)
Y6		
12+00	6	41
12+50	0	40

Station	Uncl. Exc. (cu. yd.)	Embt (15%) (cu. yd.)
Y7		
10+50	73	0
11+00	44	0

Station	Uncl. Exc. (cu. yd.)	Embt (15%) (cu. yd.)
PATH2		
10+00	5	6
10+50	4	28
11+00	8	71
11+50	8	90
12+00	8	95
12+50	9	150
13+00	10	235
13+50	9	267
14+00	8	149
14+50	29	2
15+00	78	0
15+50	59	1
16+00	6	7
16+50	4	9
17+00	3	47
17+50	0	44

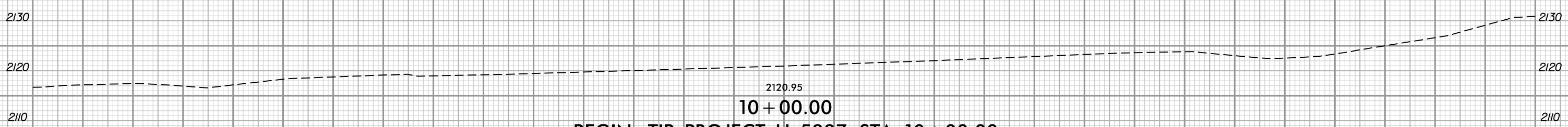
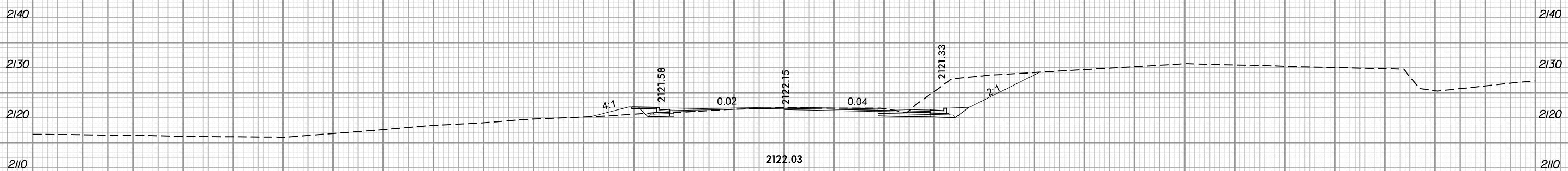
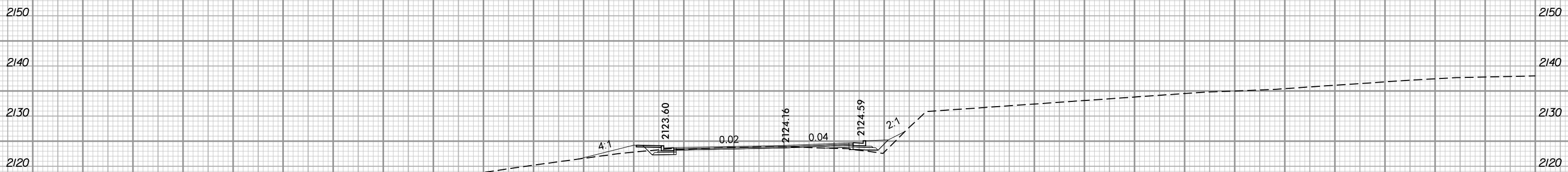

BEGIN TIP PROJECT U-5887 STA. 10 + 00.00

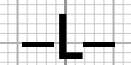

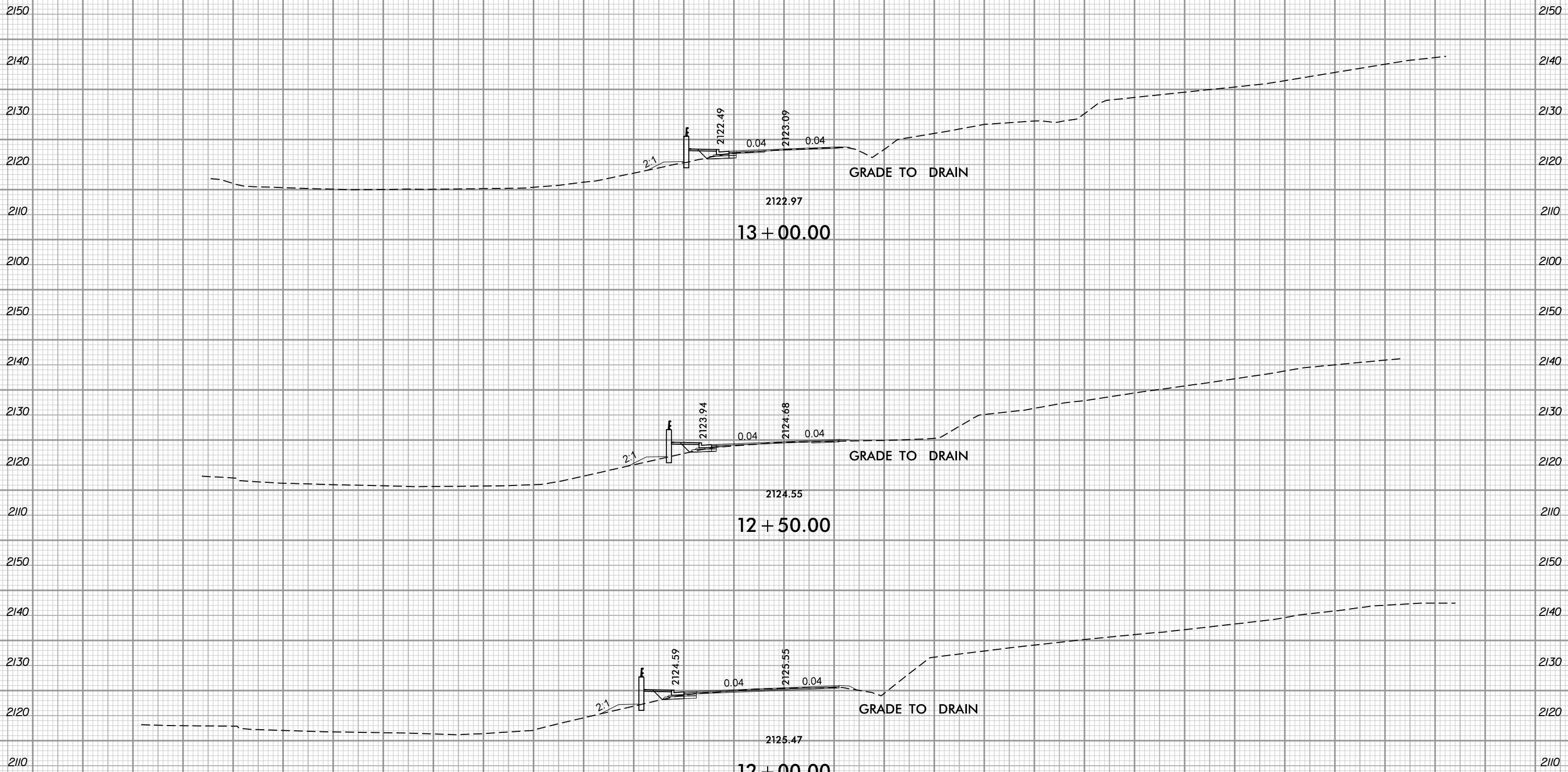

6/9/2020 2:02:02 PM
User: jcm11106

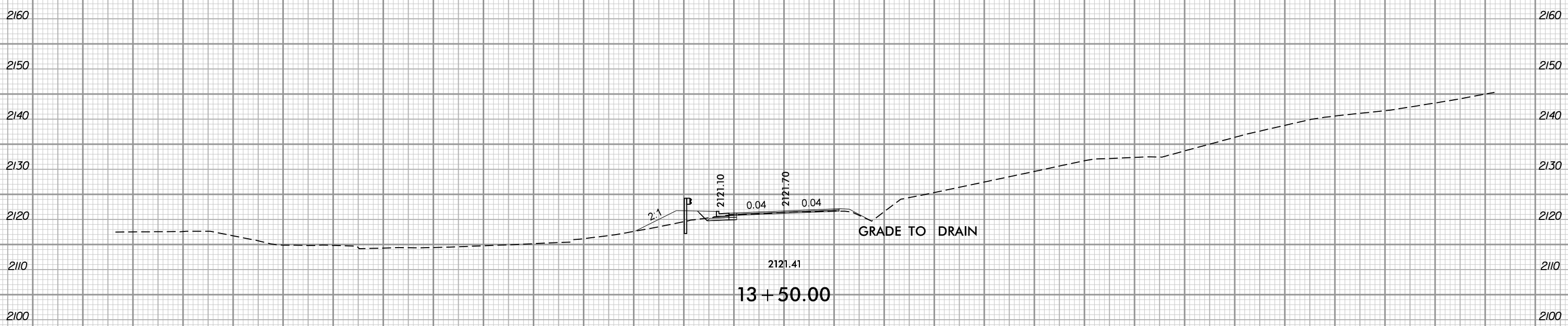
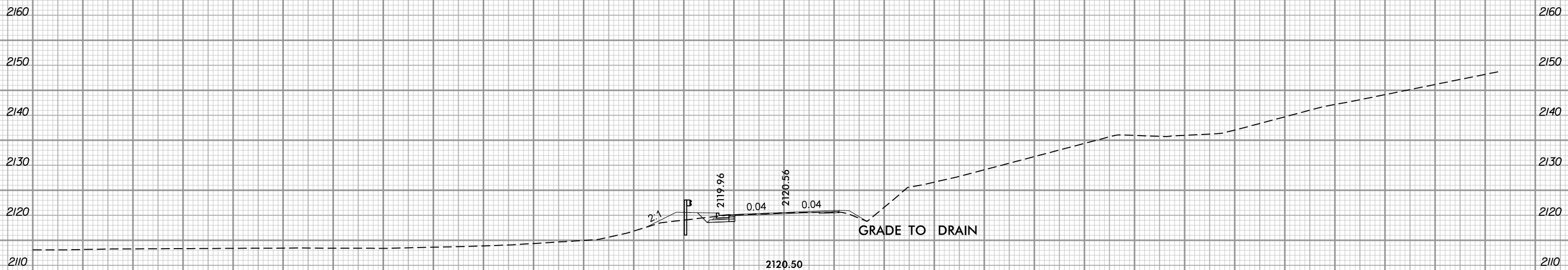

6/9/2020 2:02:02 PM
User: jcm1106



6/25/2020

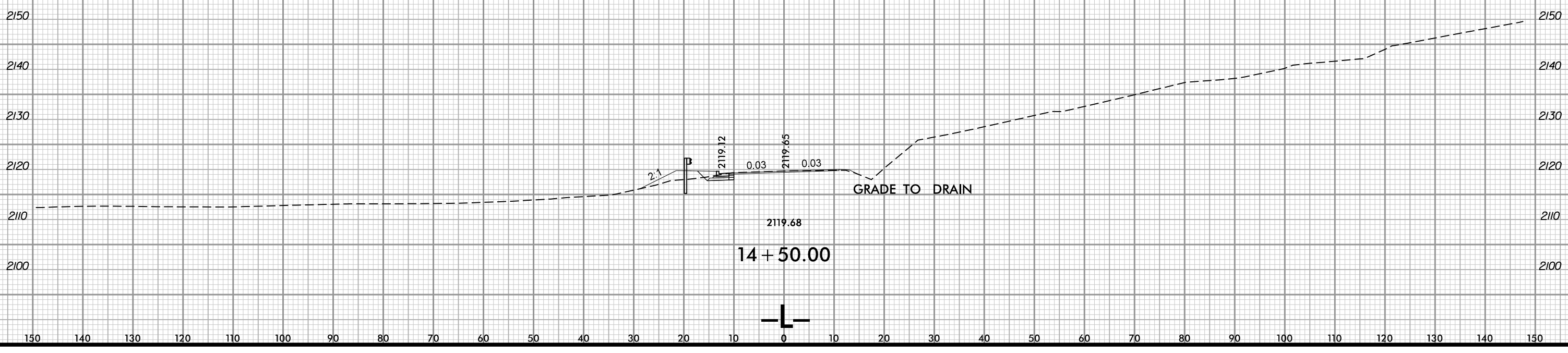
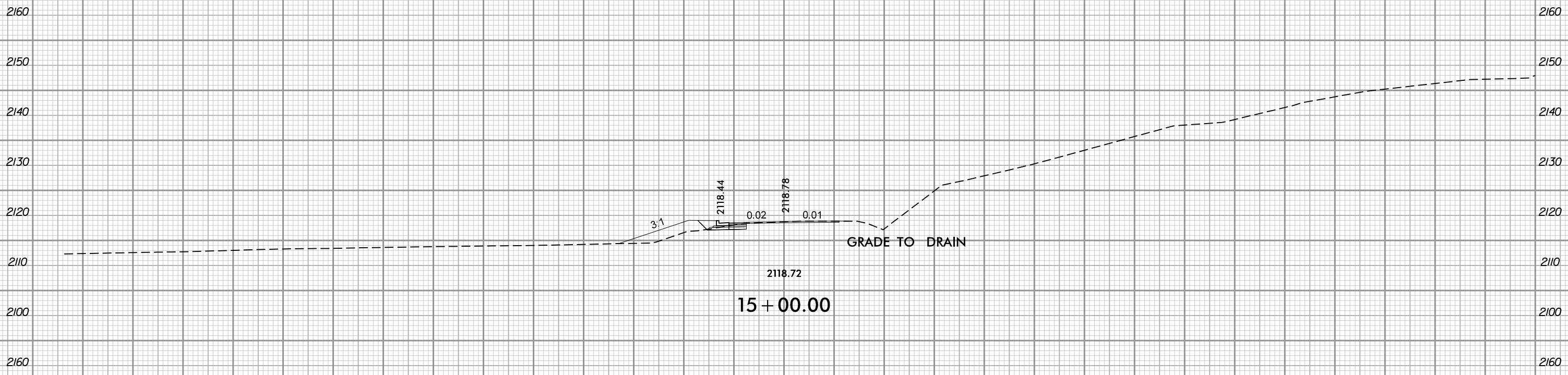

6/9/2020 2:02:02 PM
User: jcm1106

6/25/2020

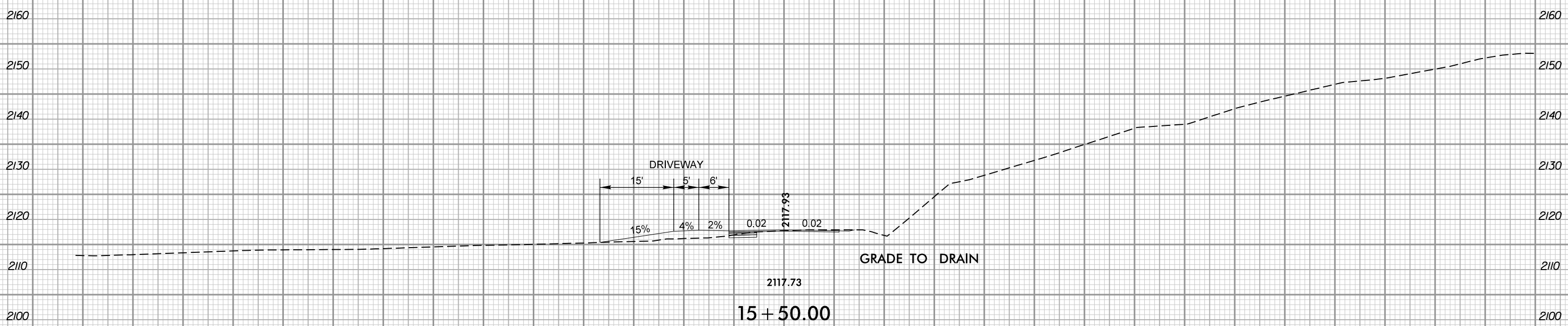
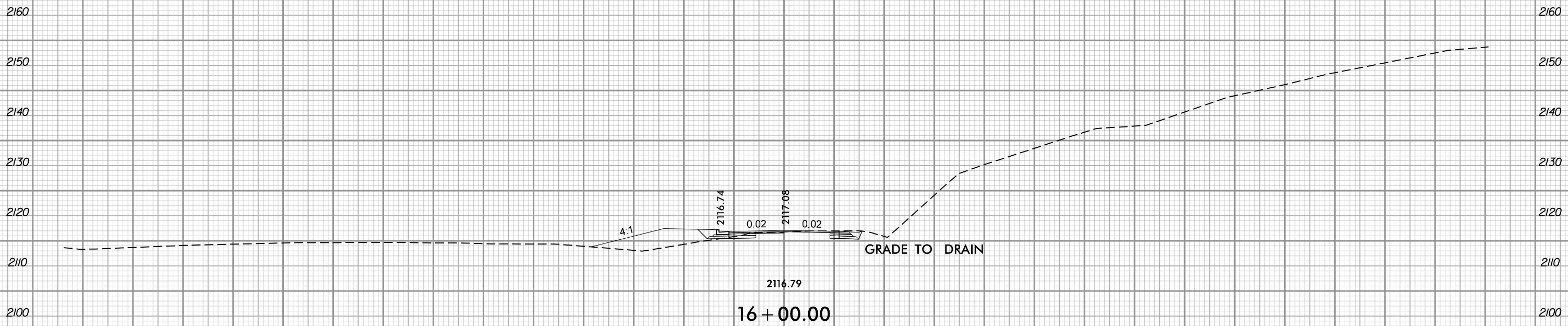

6/9/2020 2:02:02 PM
User: jcm11102

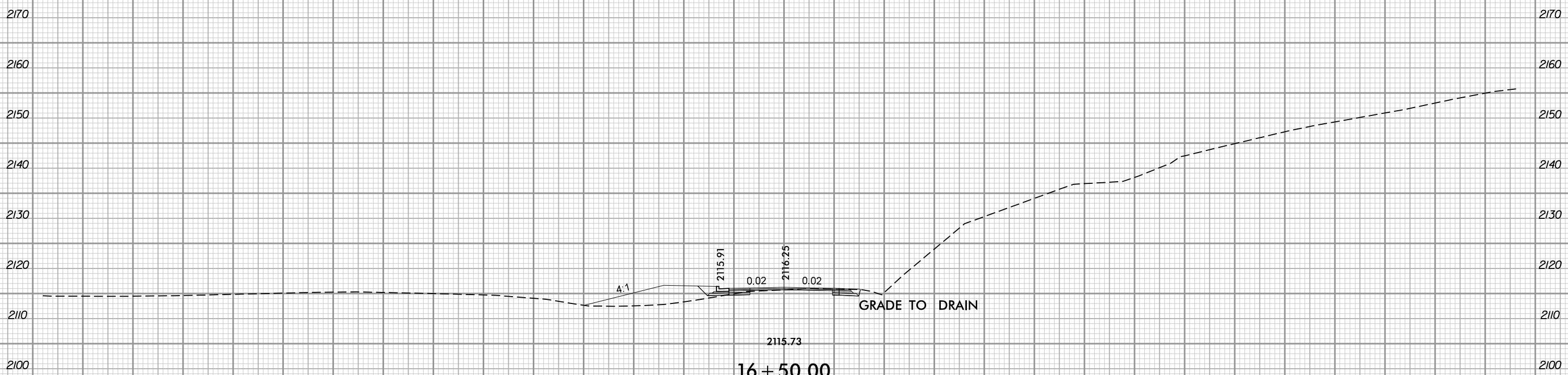
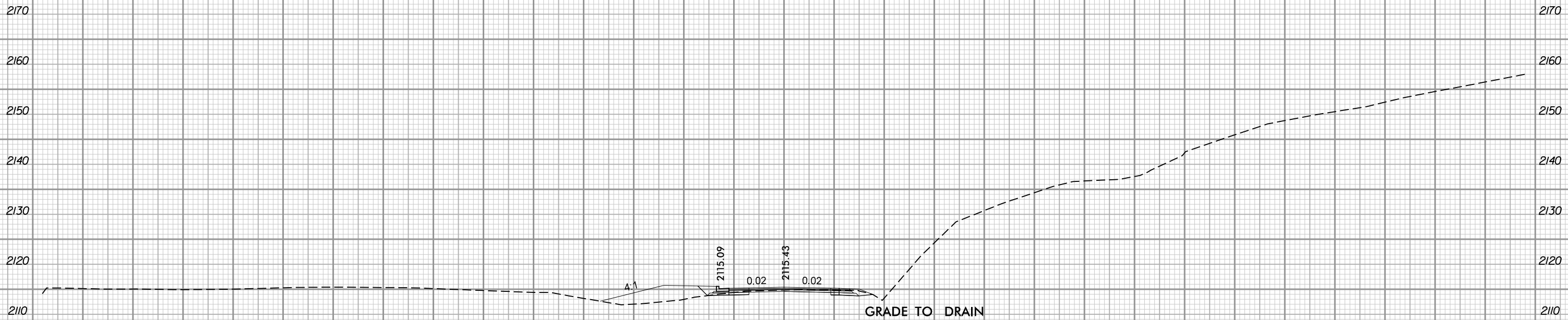

6/9/2020 2:02:02 PM
User: jcm1106

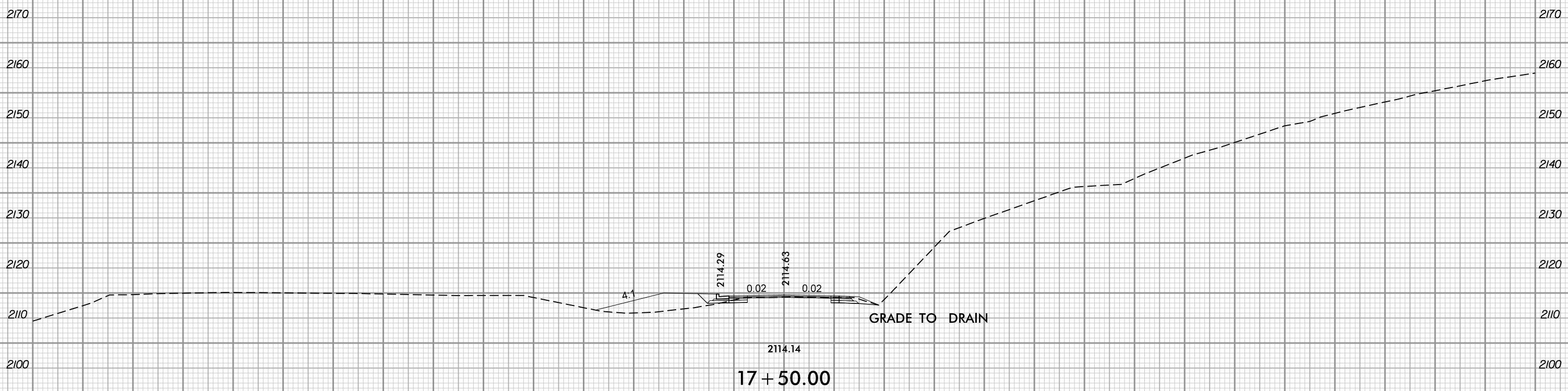
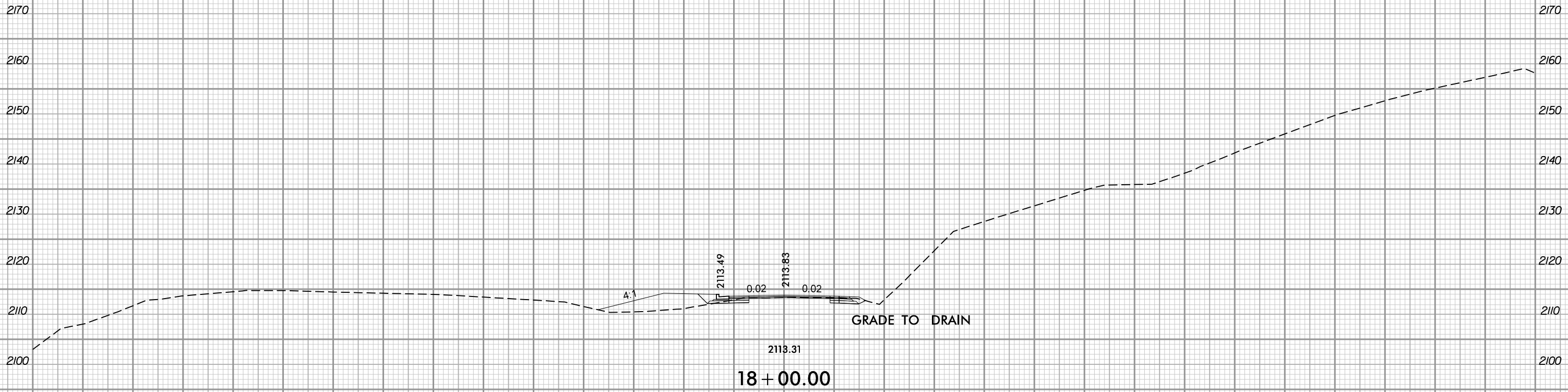

6/9/2020 2:02:02 PM
User: jcm1106

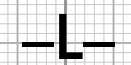

6/25/2020

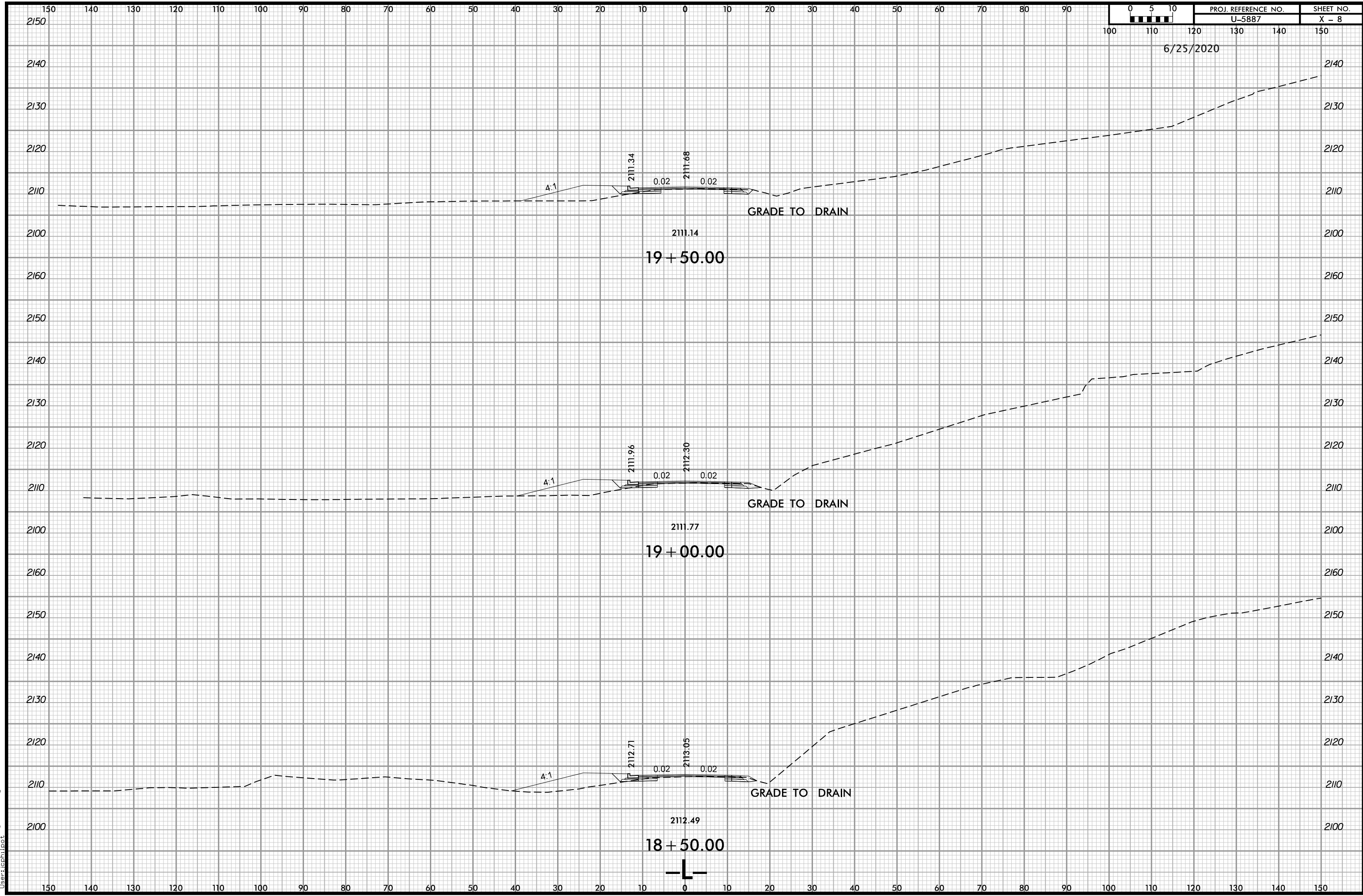

6/25/2020

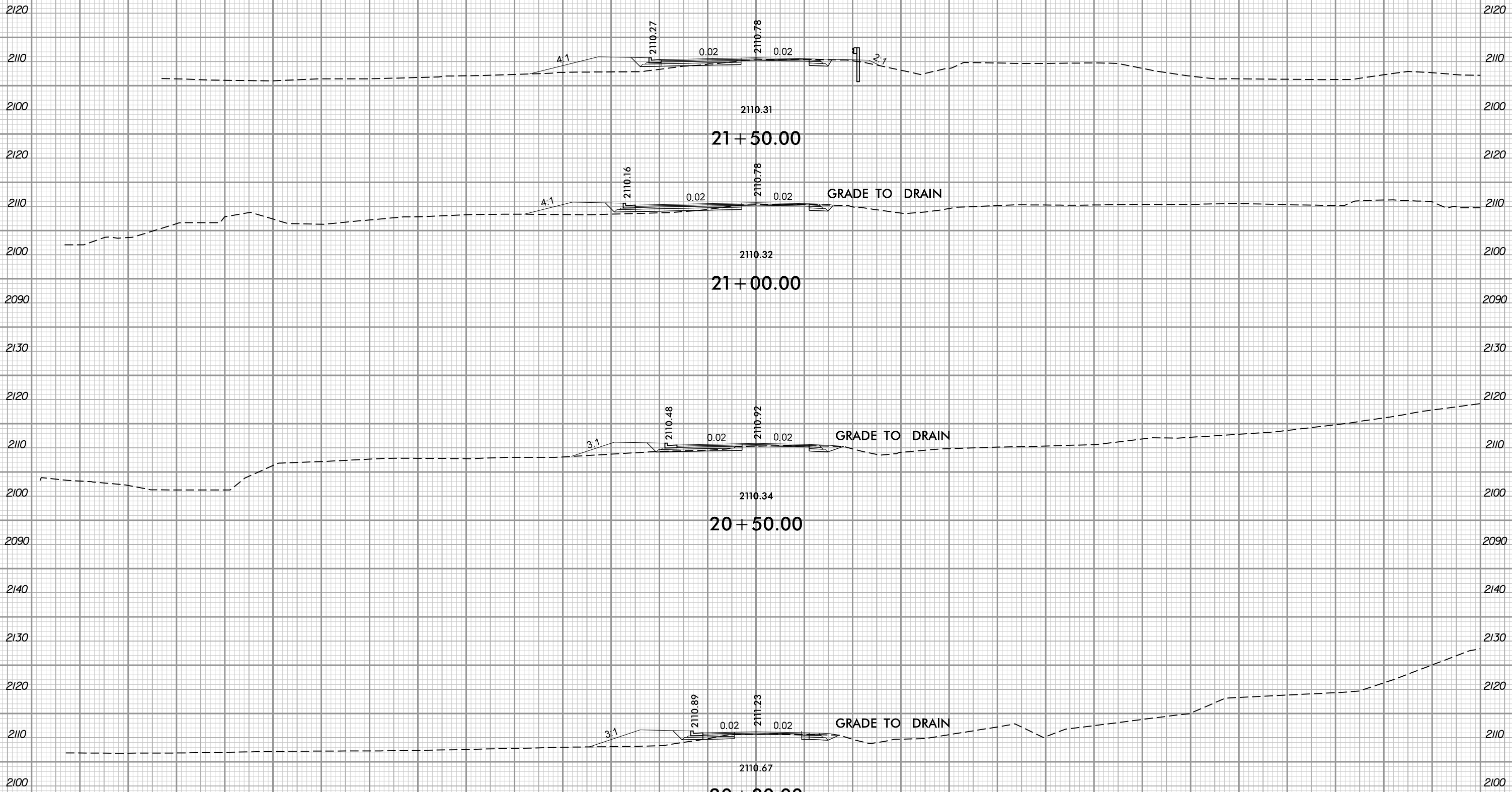

6/9/2020 2:02:02 PM
User: rjcm1106

6/25/2020

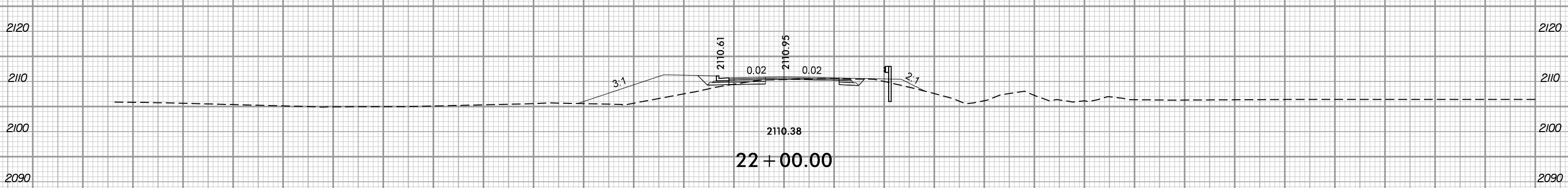
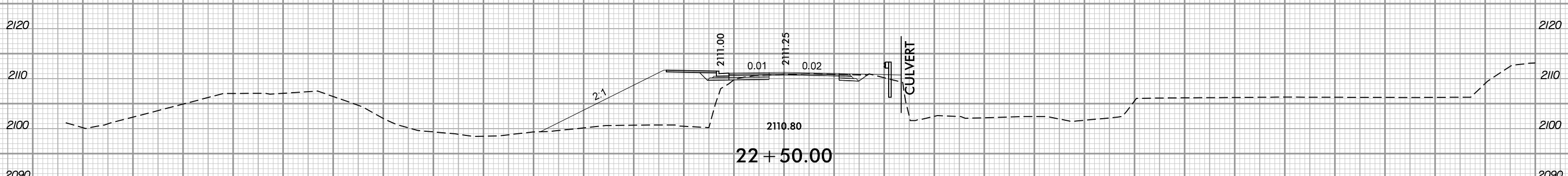
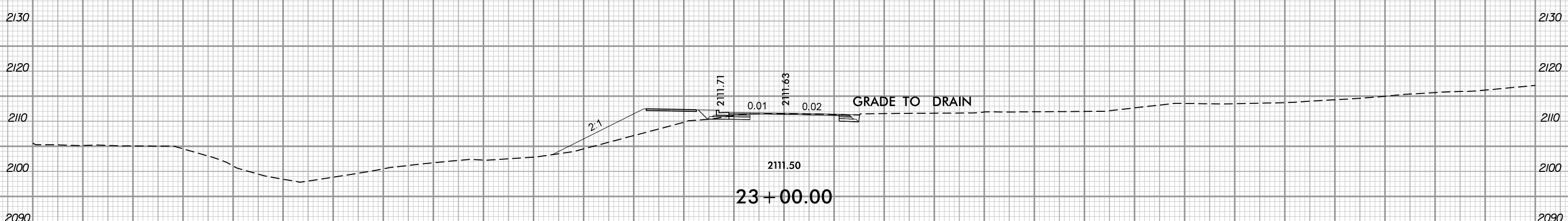
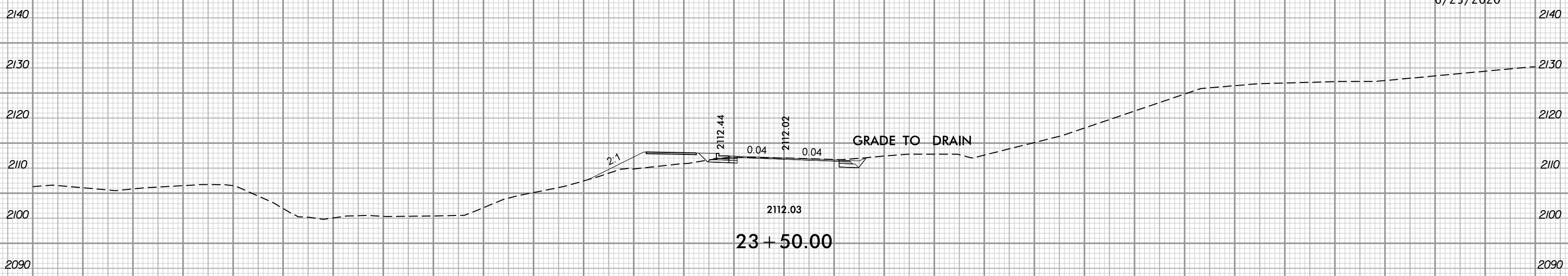

6/25/2020

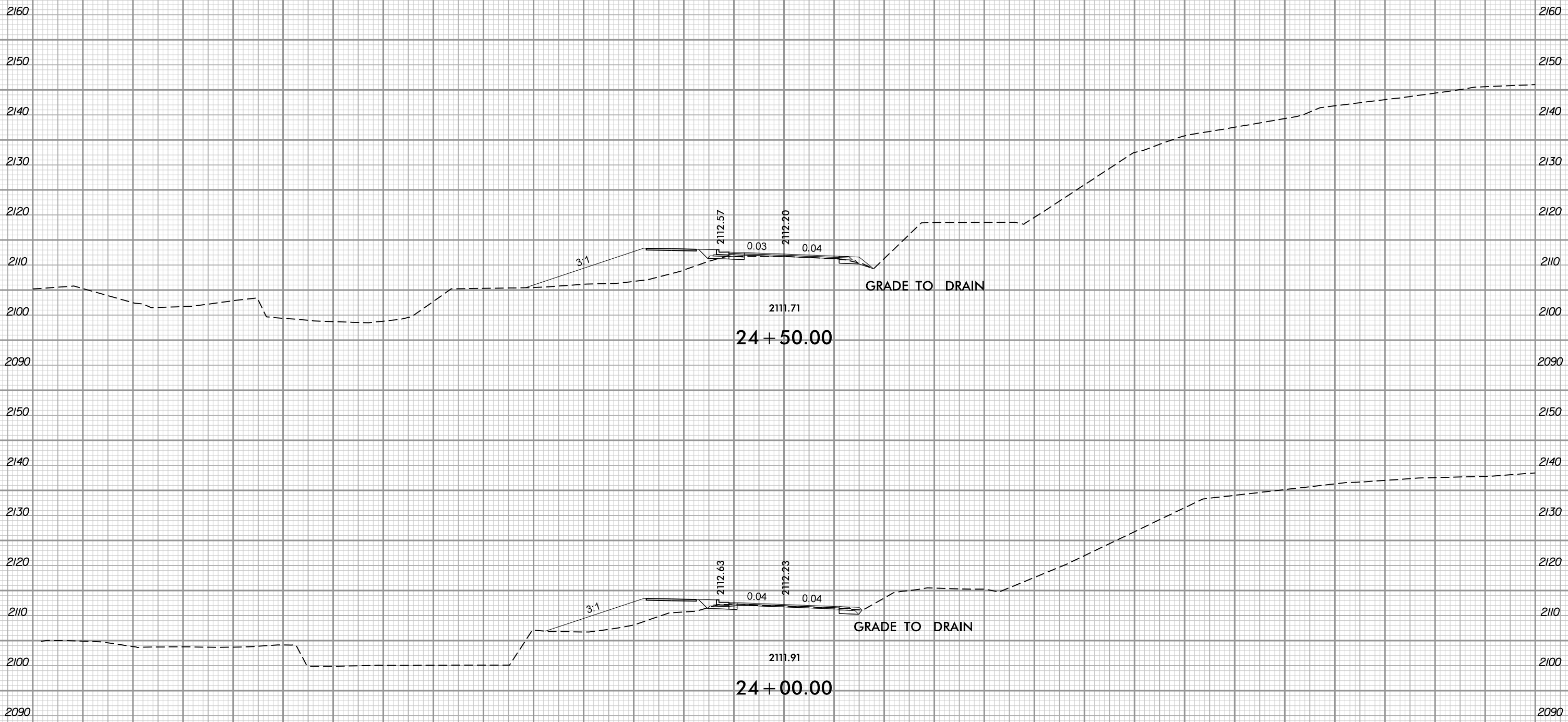

6/9/2020 2:02:02 PM
User: jcm1106

6/25/2020

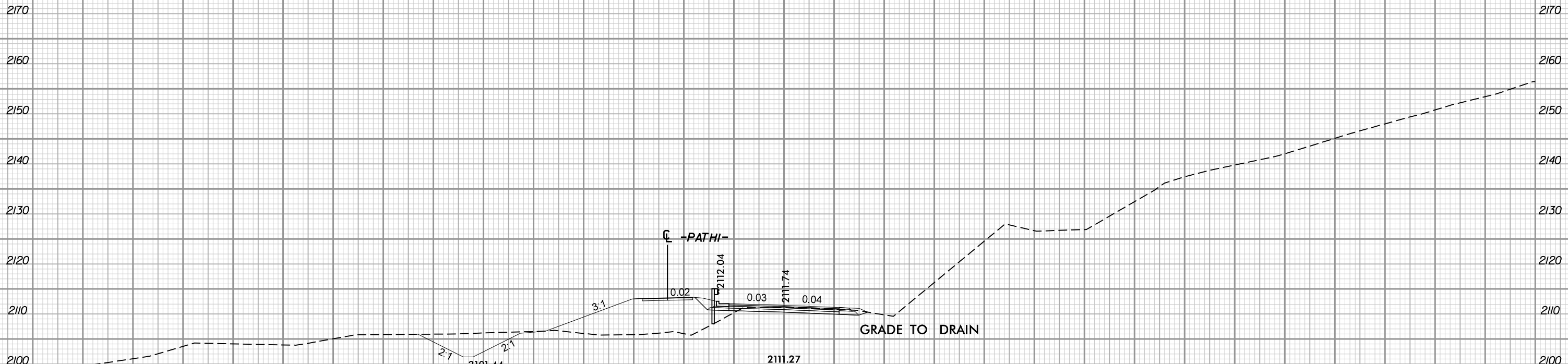

25 + 50.00

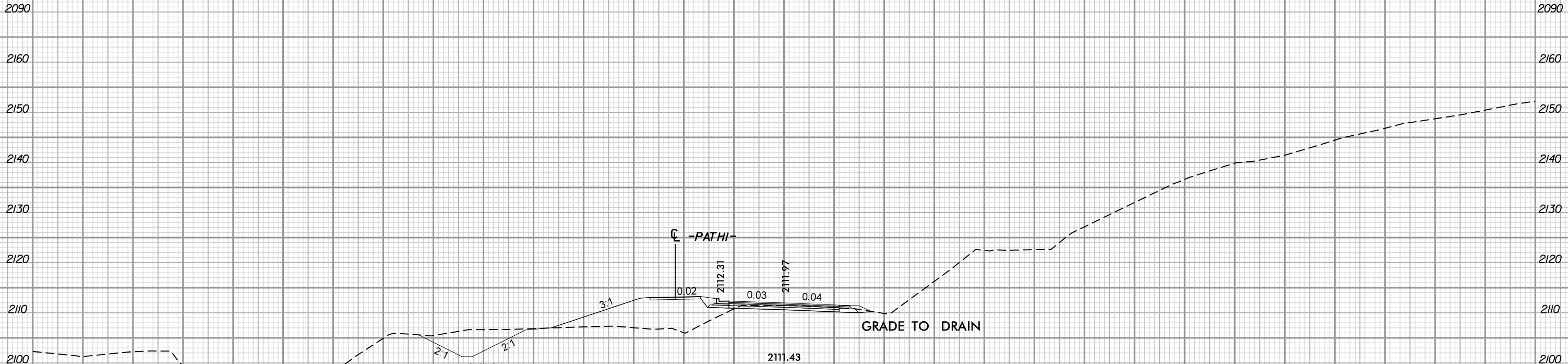

25 + 00.00

6/9/2020 2:02:02 PM
User: jcm11106

6/25/2020

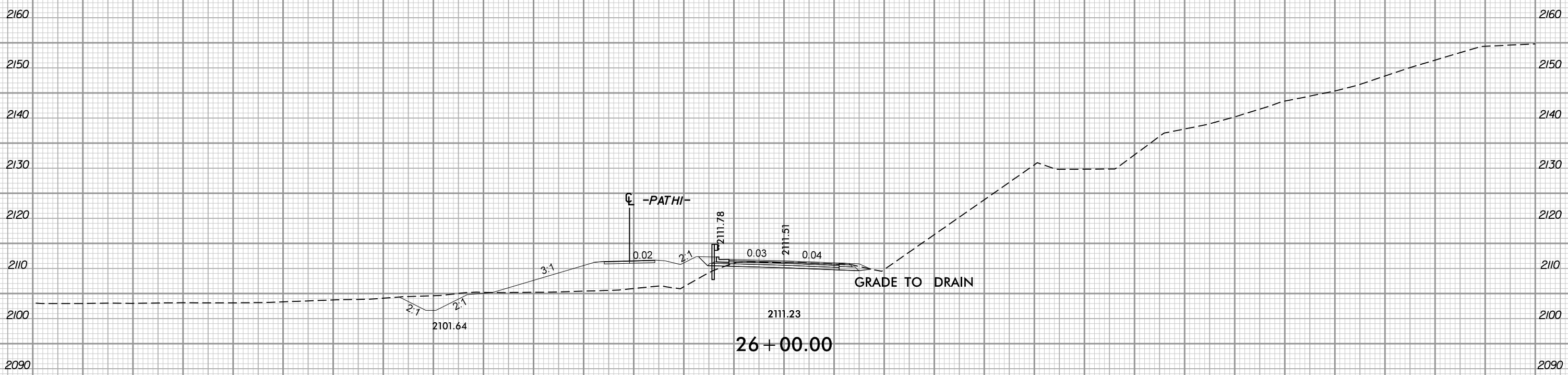
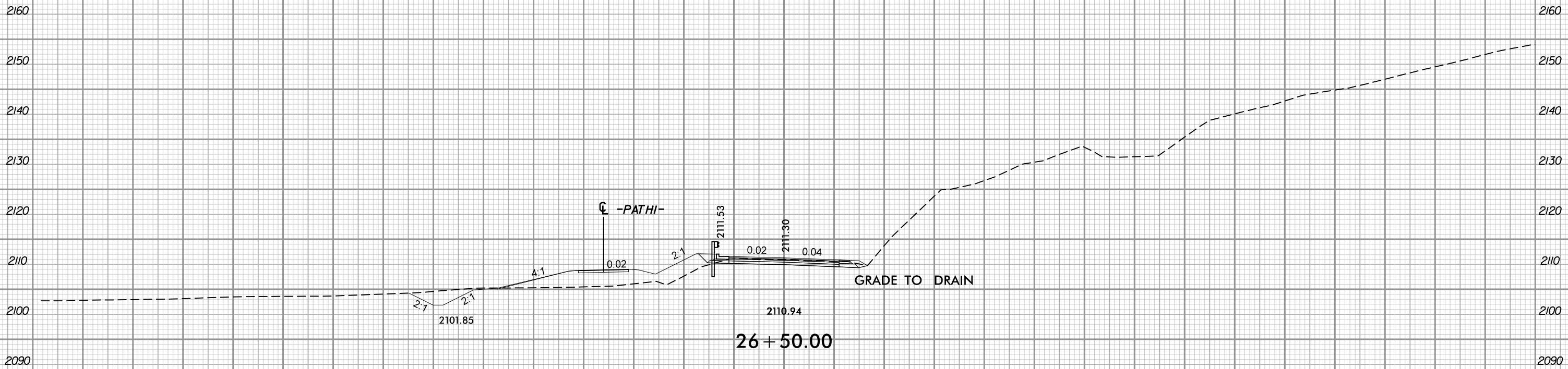

6/9/2020 2:02:02 PM
User: jcm11106

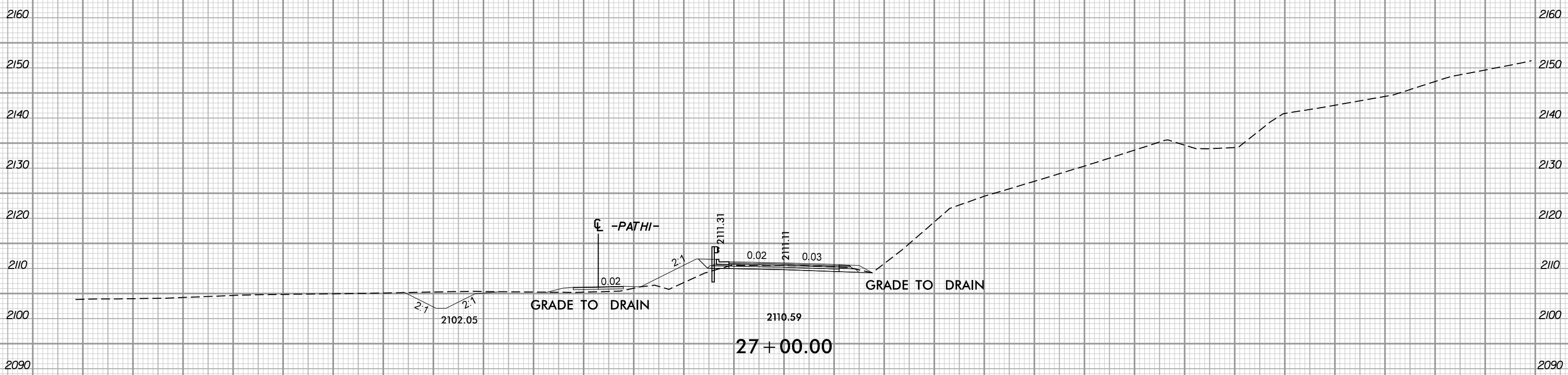
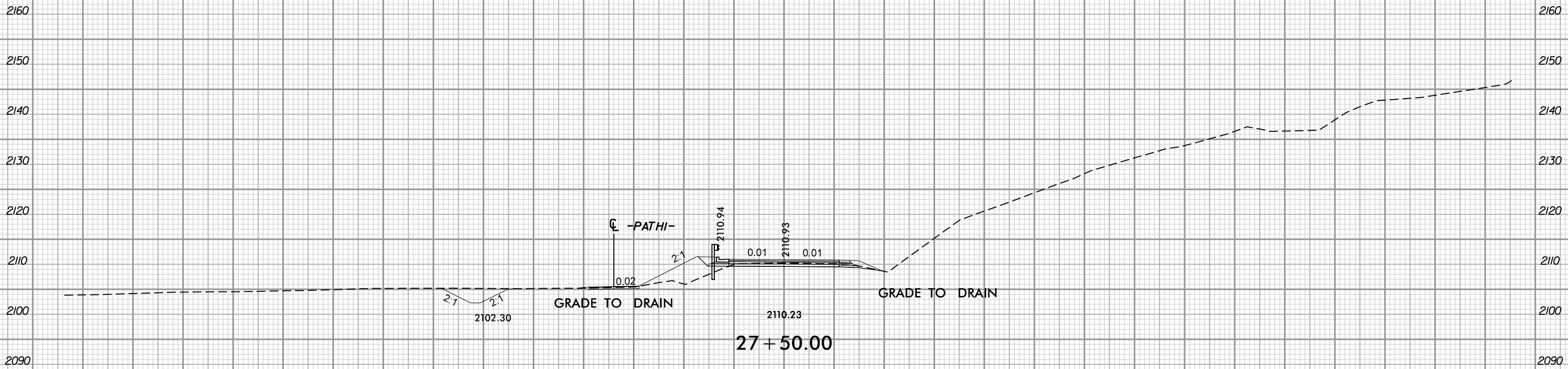

6/9/2020 2:02:02 PM
User: jcm11106

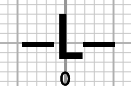

6/25/2020

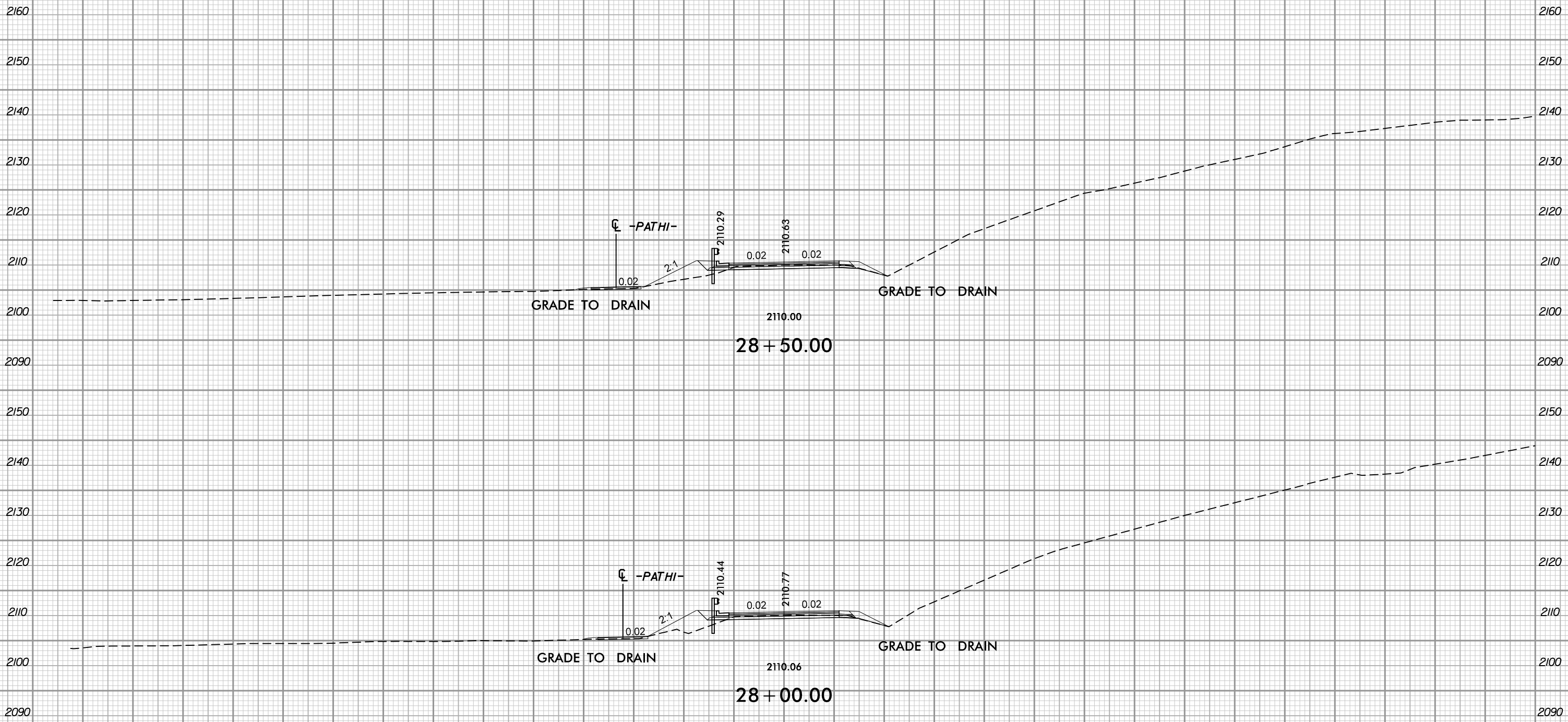

6/9/2020 2:02:02 PM
User: rjcm1106

6/25/2020

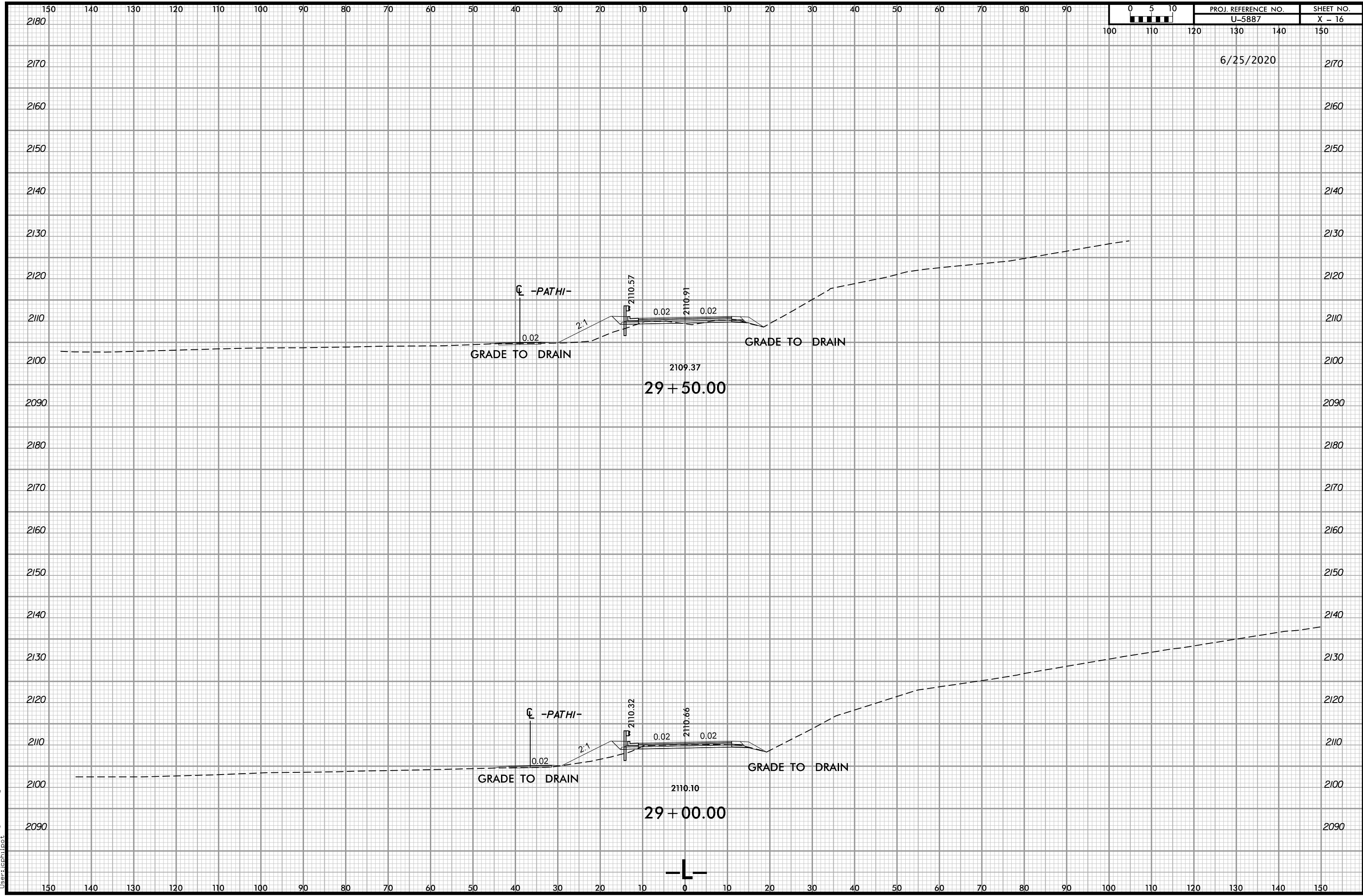

6/9/2020 2:02:02 PM
 ..\Xsec\U-5887_rdy_Xsc.L.dgn
 User:alcm1106

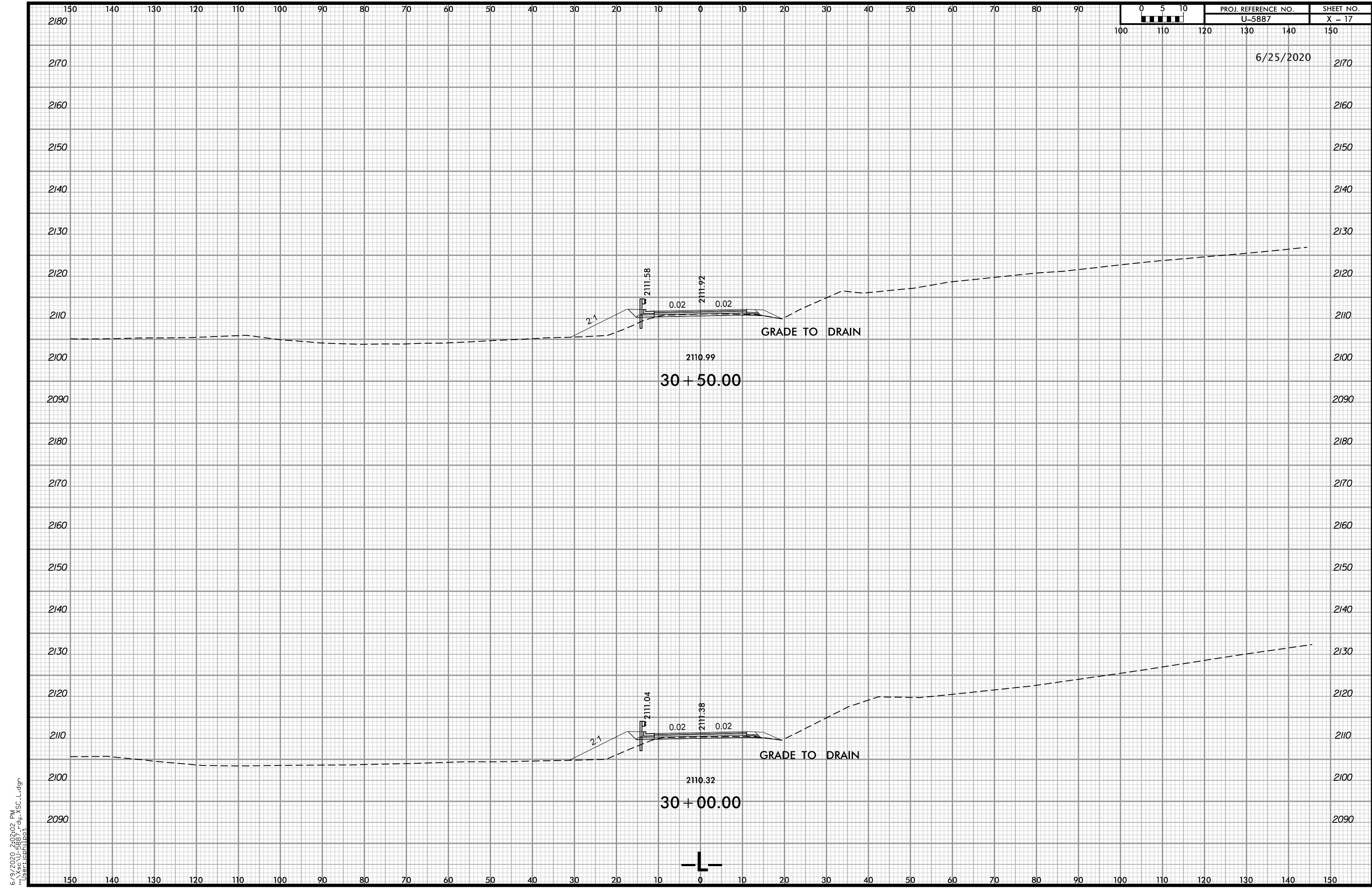

6/9/2020 2:02:02 PM
 \\Xsec\U-5887_rdy_Xsc.L.dgn
 User:alcm1106

6/25/2020

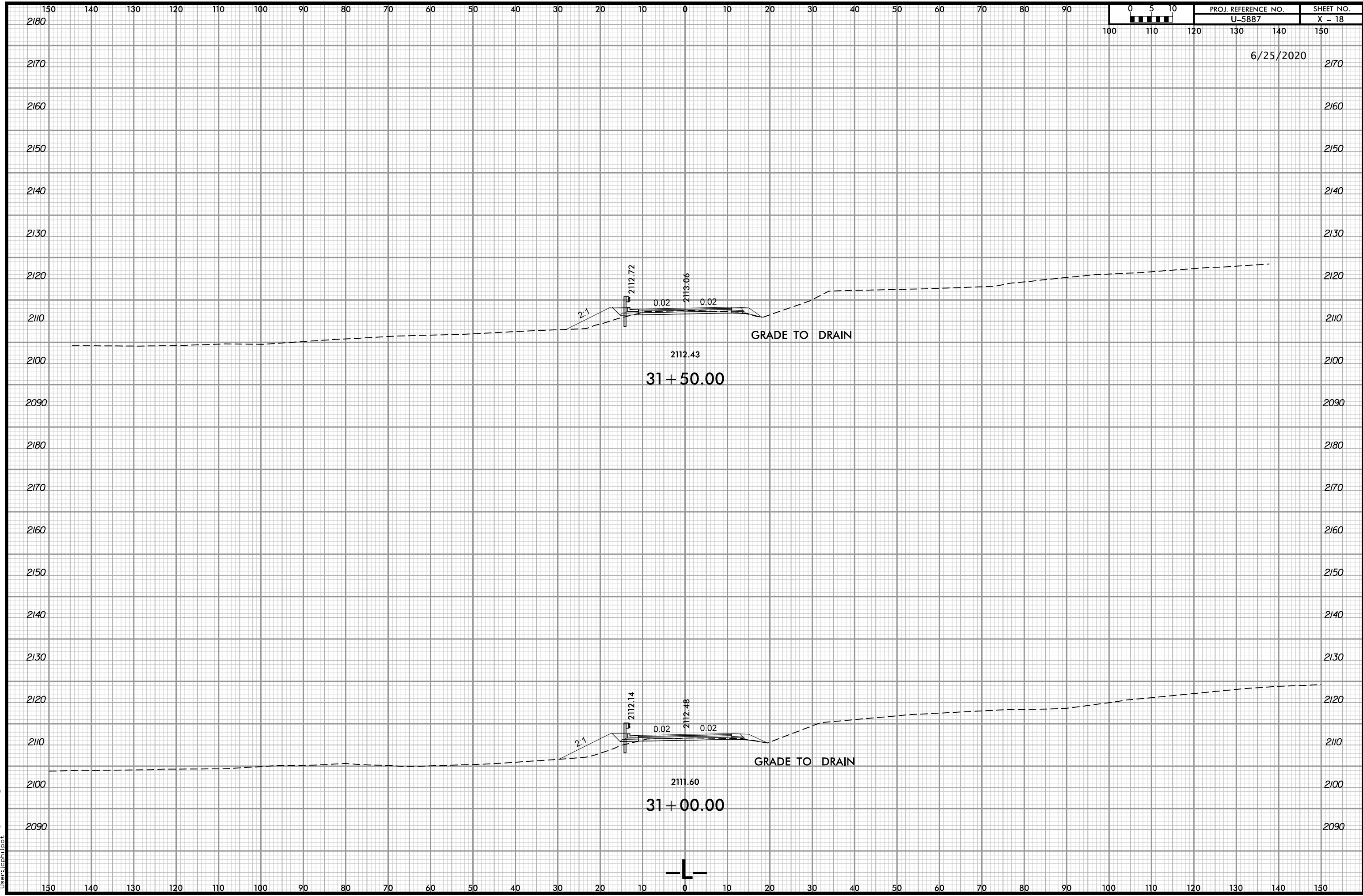

6/9/2020 2:02:02 PM
 ..\Xsec\U-5887_rdy_Xsc.L.dgn
 User:alcm1106

6/9/2020 2:02:02 PM
User: jcm1106

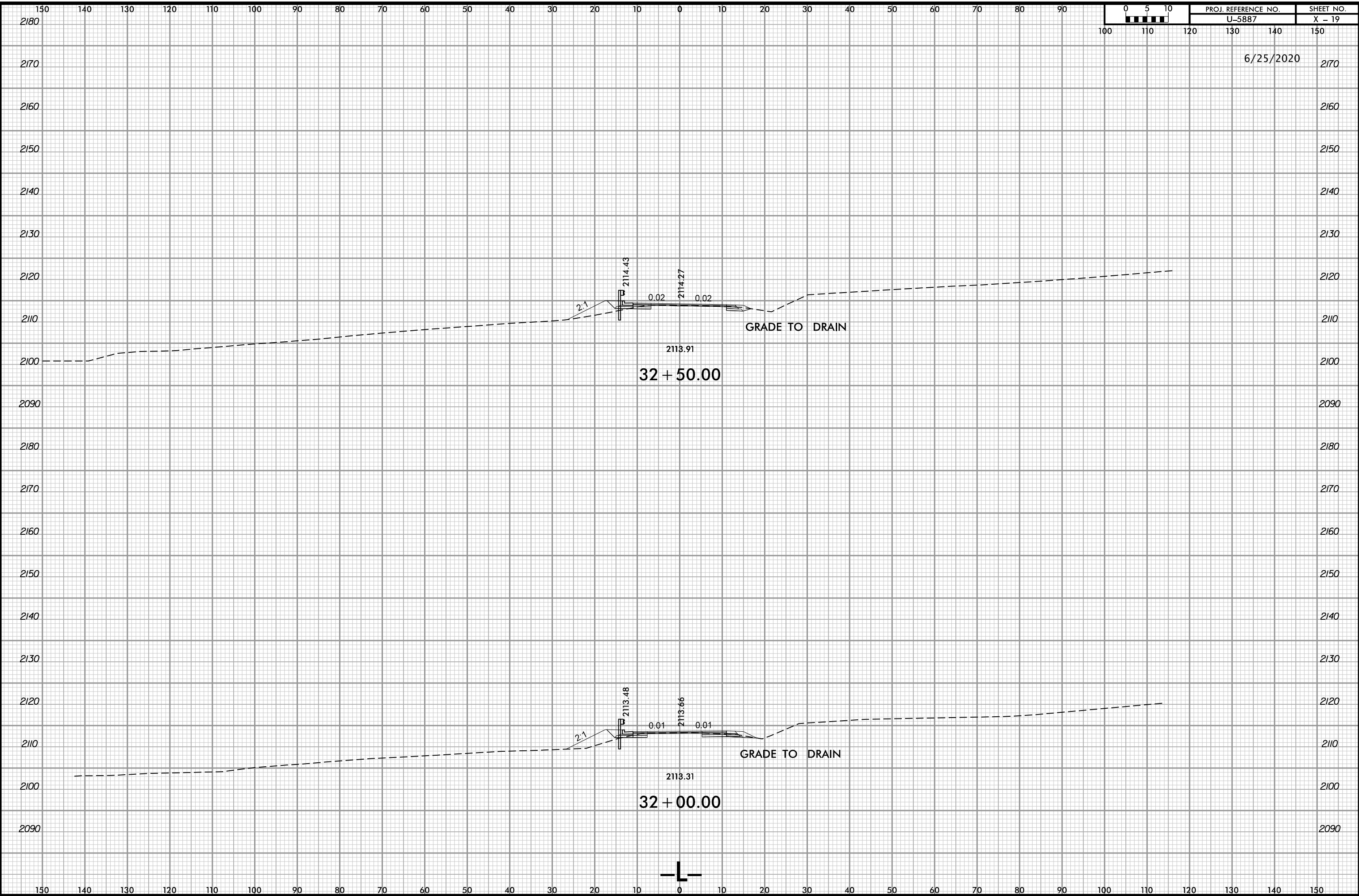

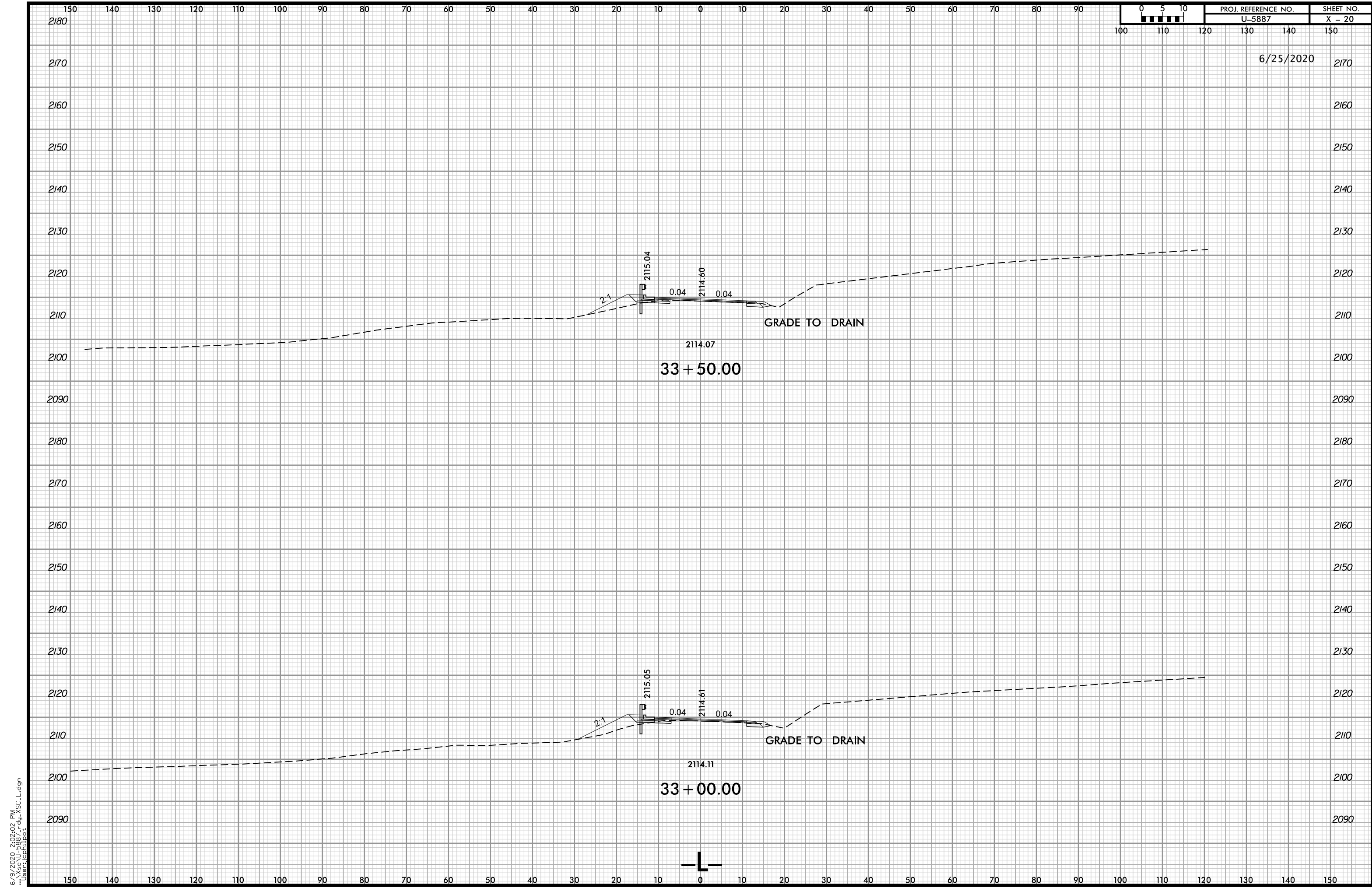

6/9/2020 2:02:02 PM
 ..\Xsec\U-5887_rdy_Xsc.L.dgn
 User: jcm1106

6/25/2020 2170

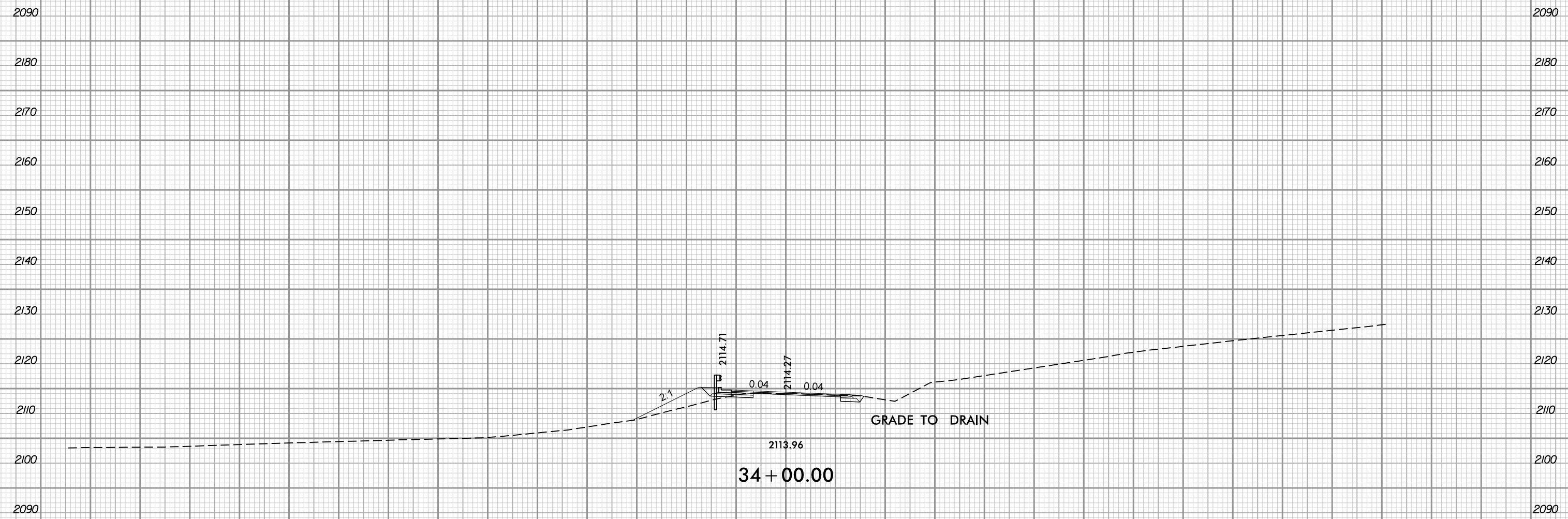
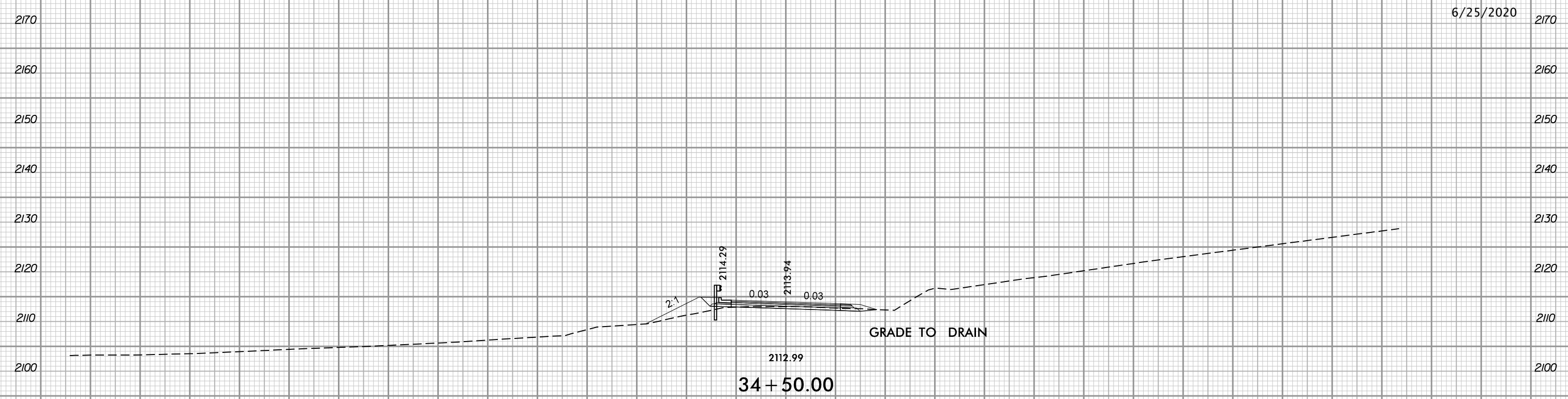

6/25/2020

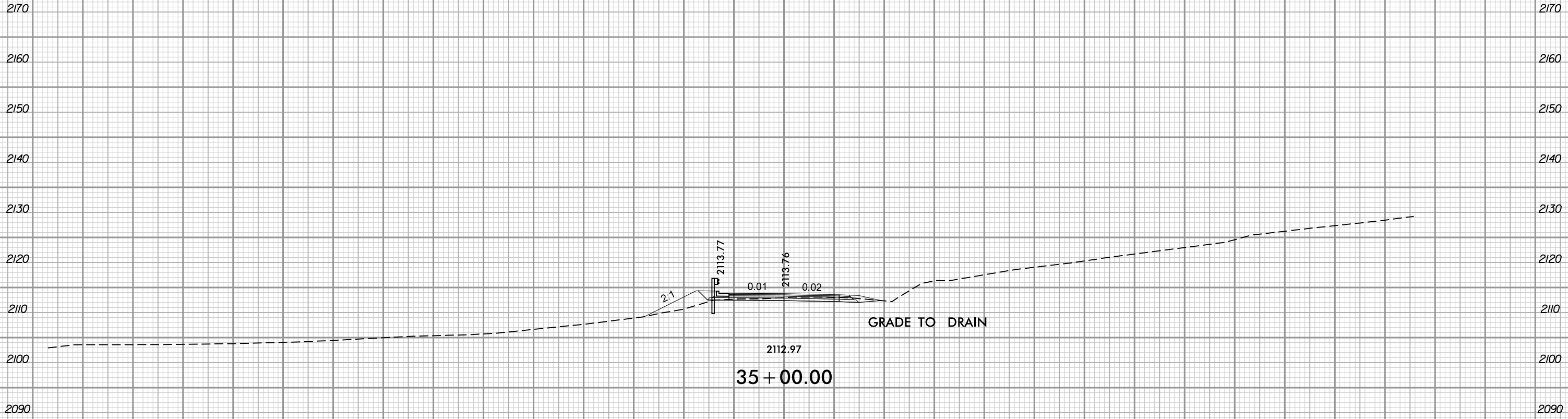
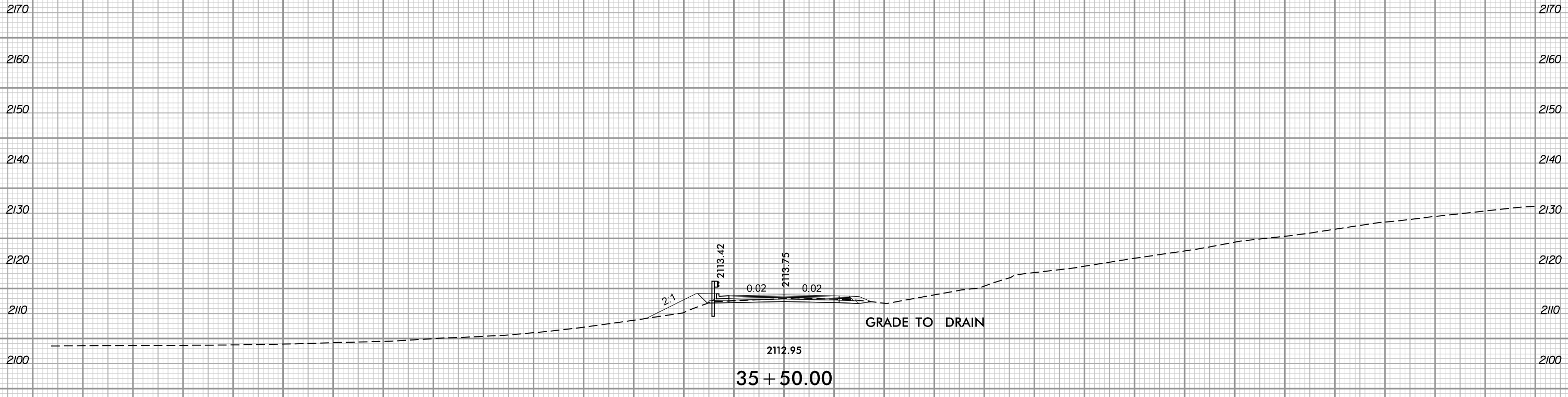

6/9/2020 2:02:02 PM
User: jcm1106

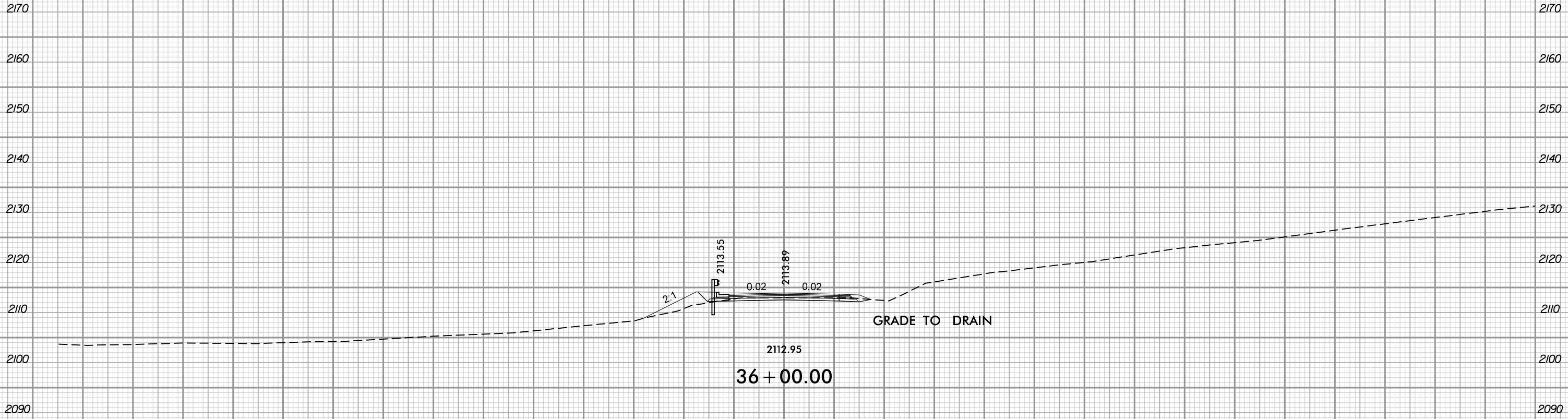
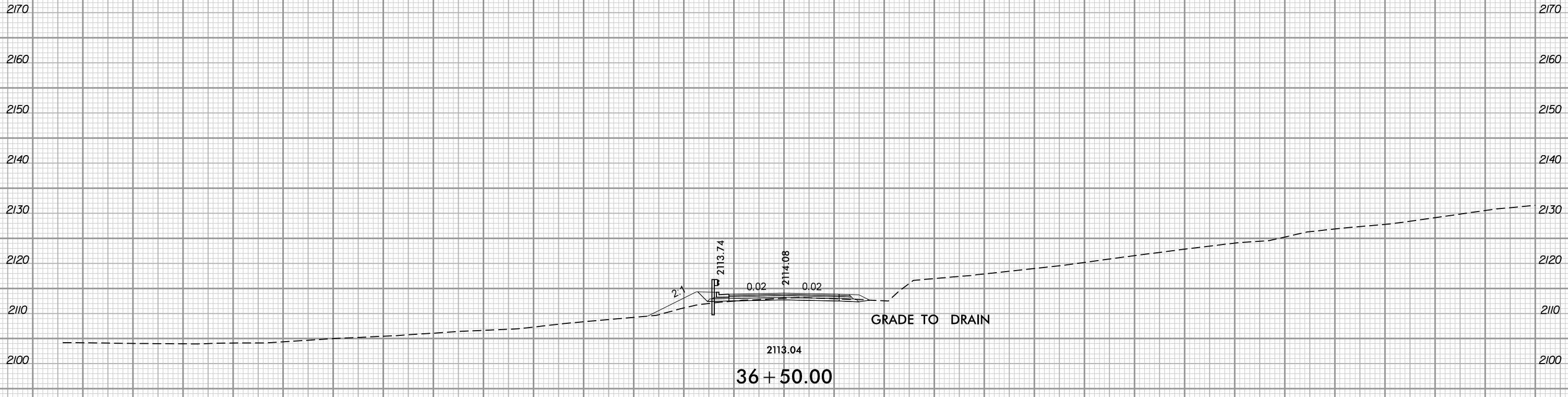

6/9/2020 2:02:02 PM
User: jcm1106

6/25/2020

2170 2170

2160 2160

2150 2150

2140 2140

2130 2130

2120 2120

2110 2110

2100 2100

2090 2090

2170 2170

2160 2160

2150 2150

2140 2140

2130 2130

2120 2120

2110 2110

2100 2100

2090 2090

6/9/2020 2:02:02 PM
User: jcm1106

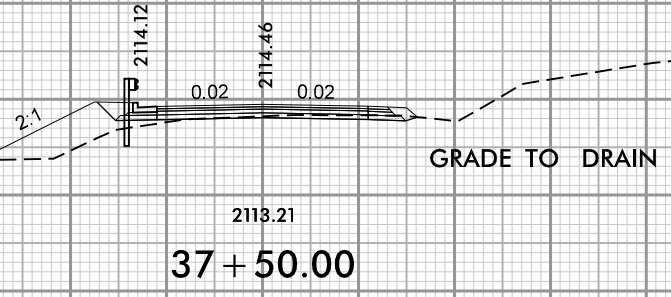

37 + 50.00

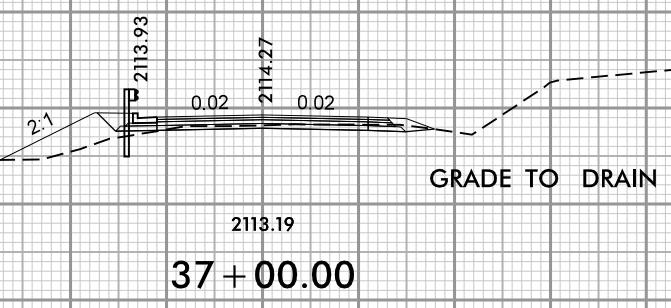

37 + 00.00

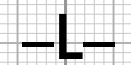

6/25/2020

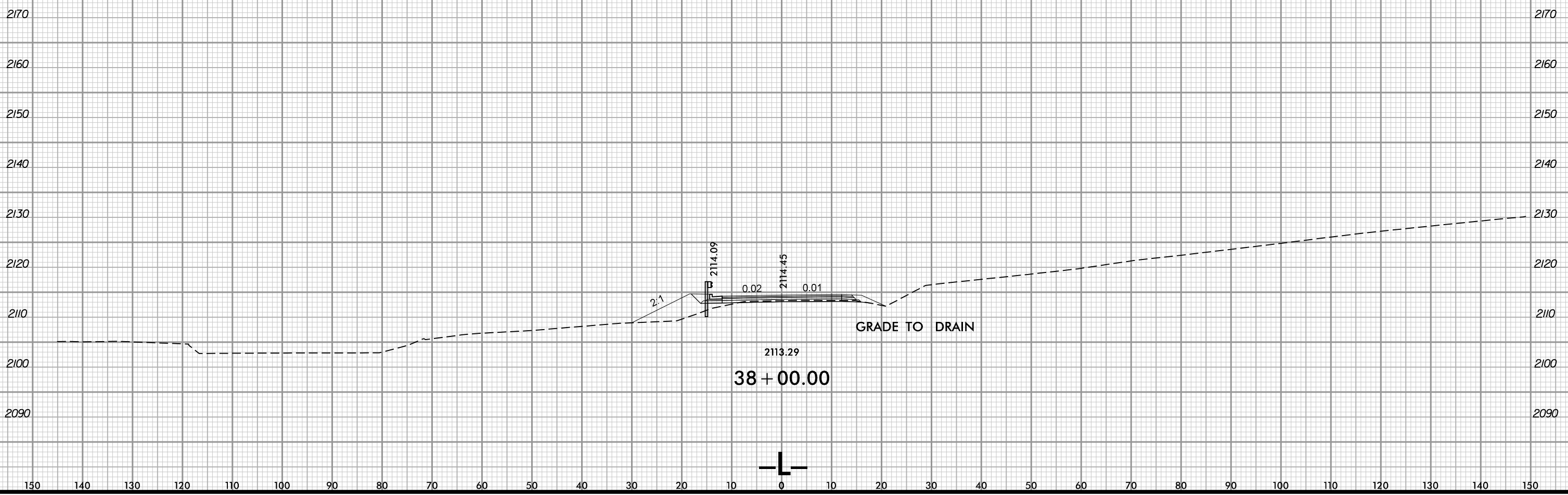
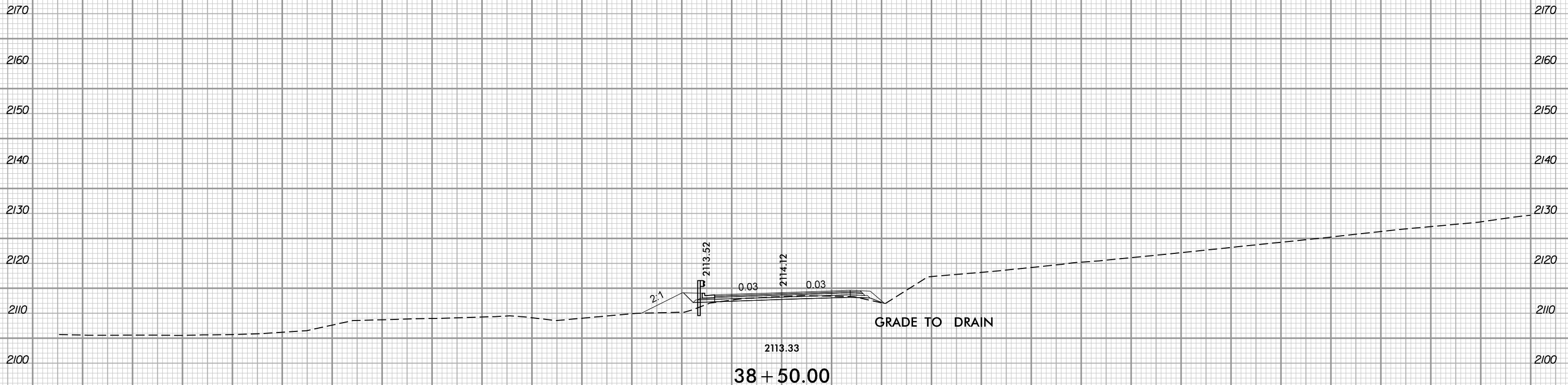

6/25/2020

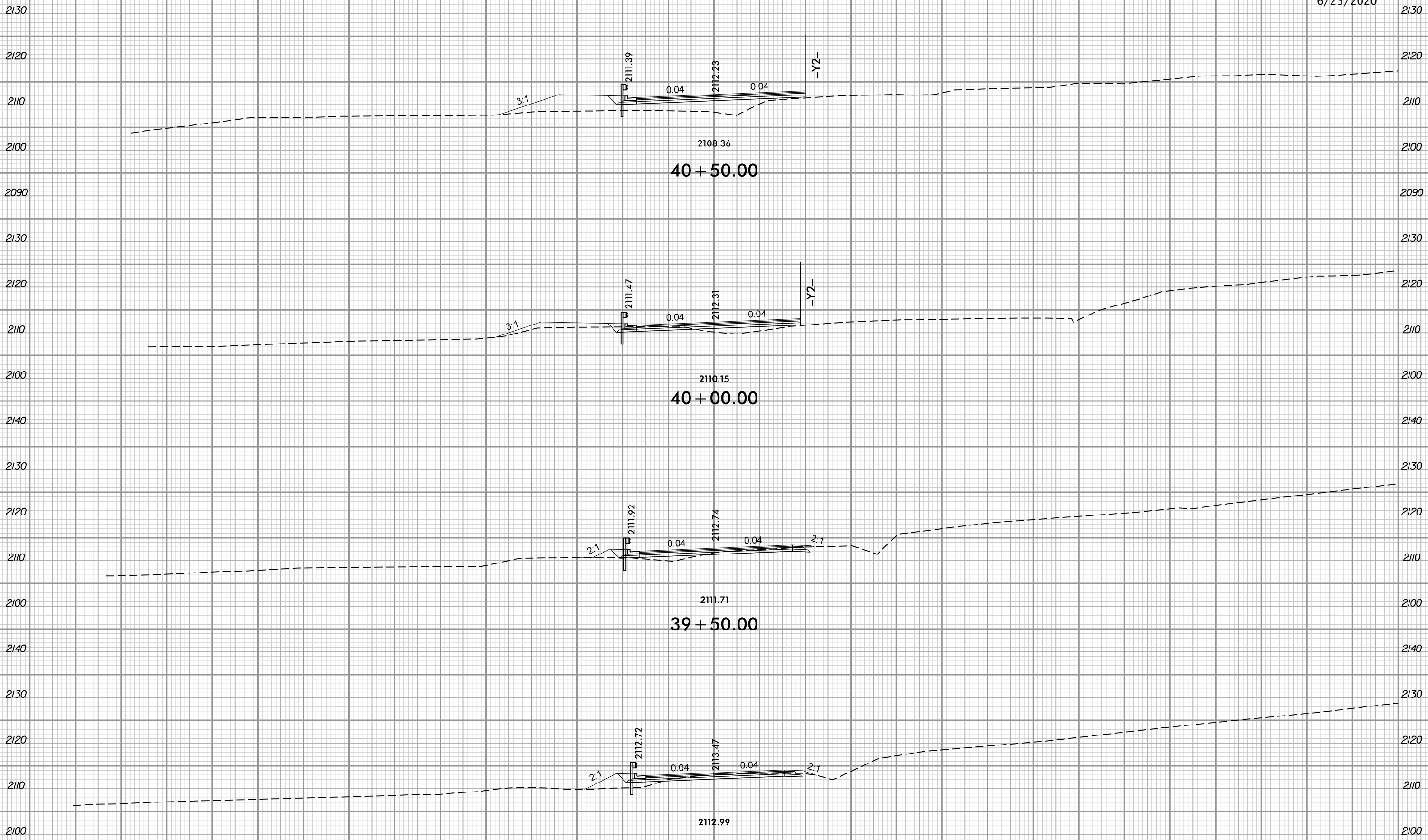

6/9/2020 2:02:02 PM
User: jcm1106

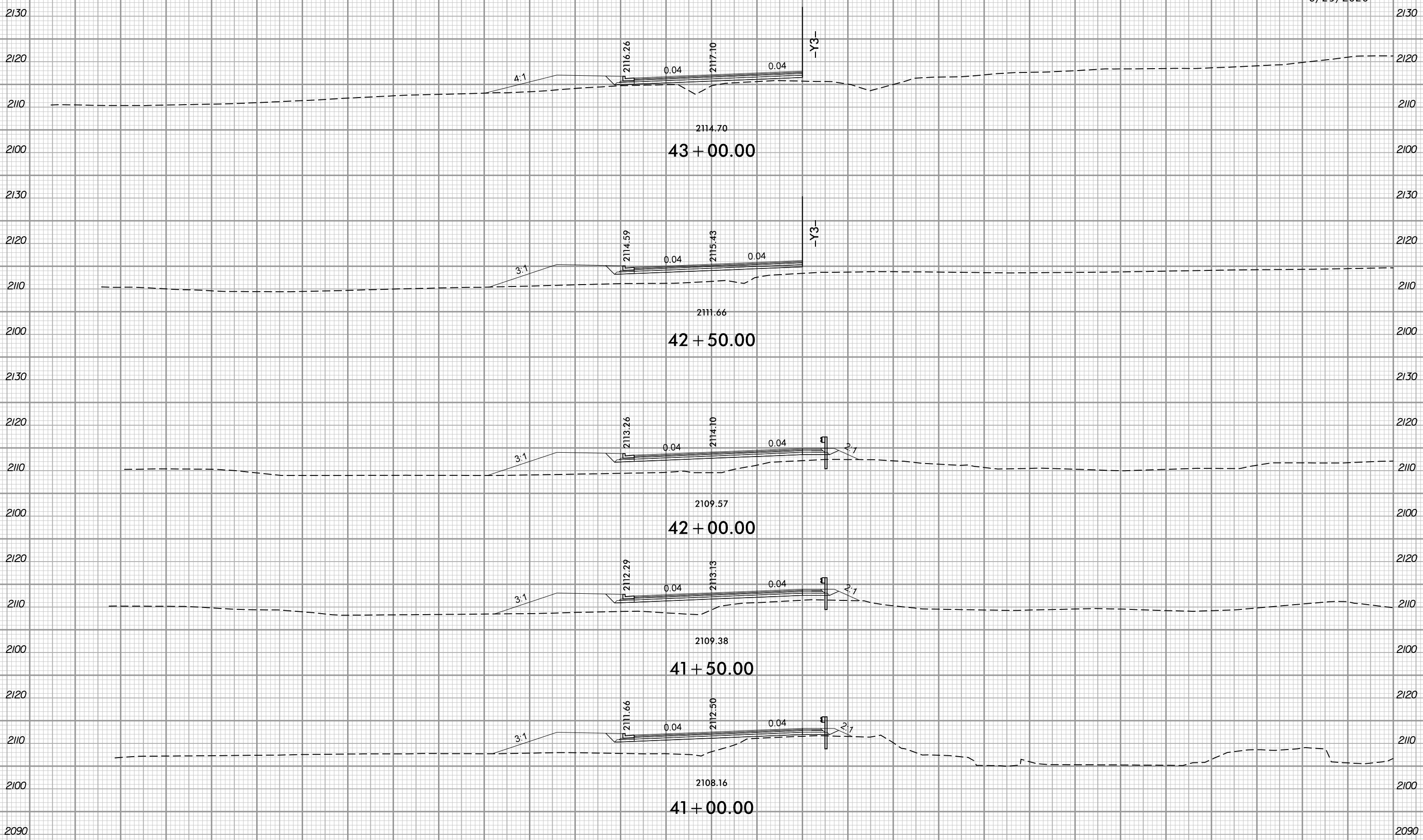

6/9/2020 2:02:02 PM
User: rjcmh1106

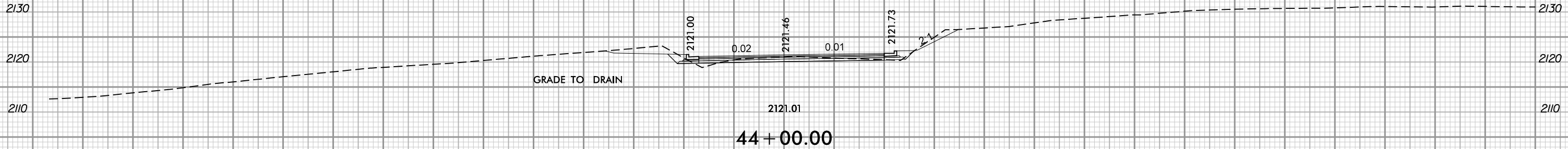
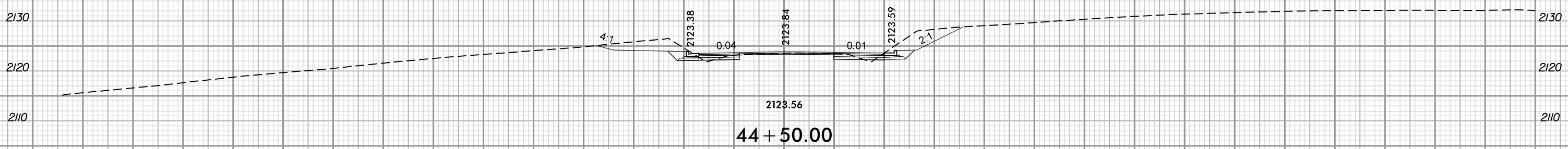
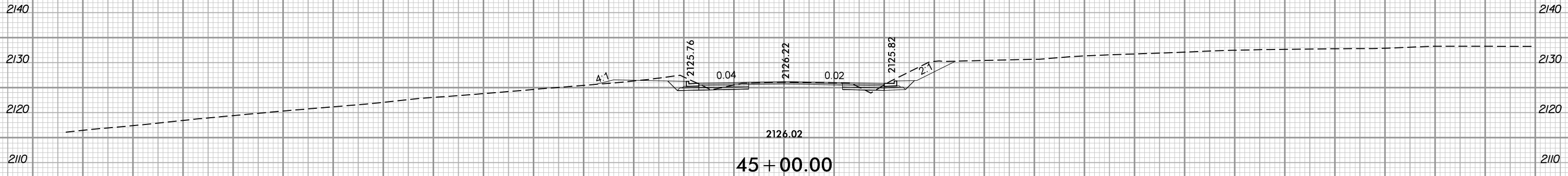

6/9/2020 2:02:02 PM
User: jgcm1106

6/25/2020

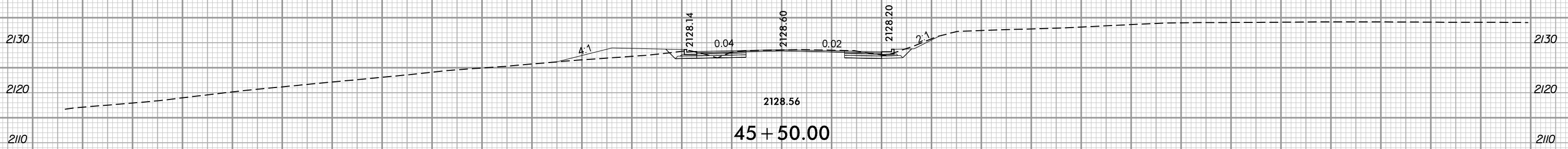
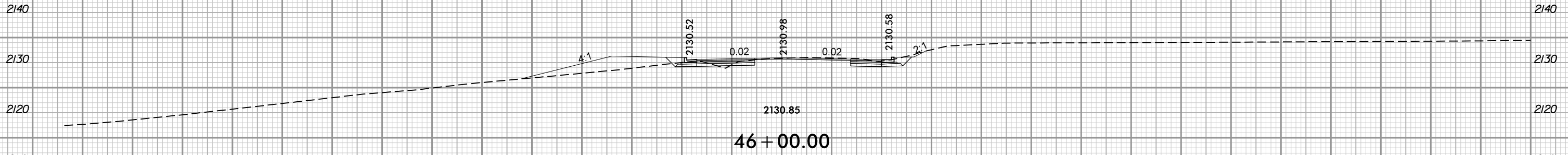
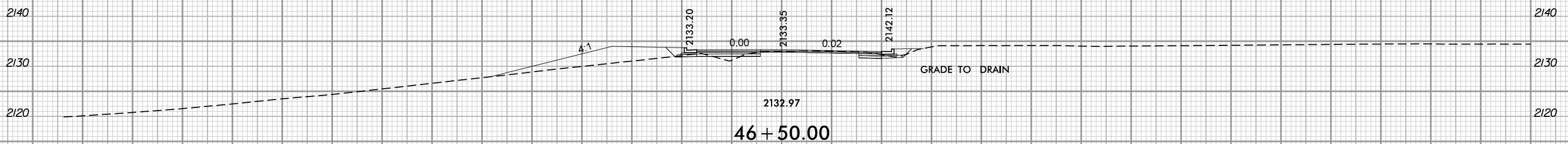
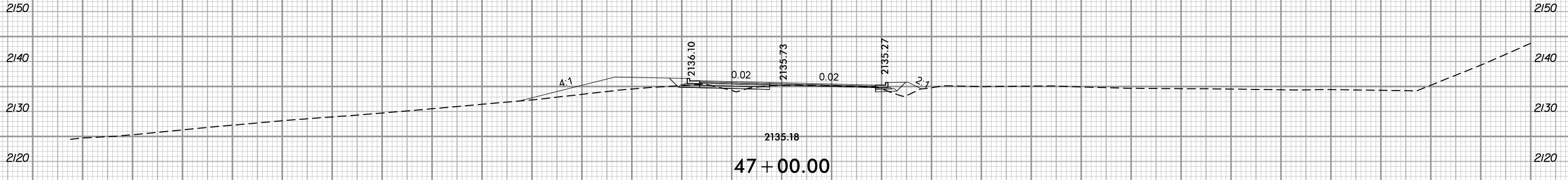

6/9/2020 2:02:02 PM
User: jcm11106

12/18/2020

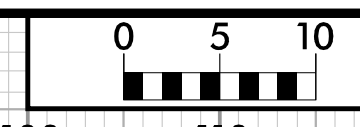

PROJ. REFERENCE NO.	SHEET NO.
U-5887	X - 30

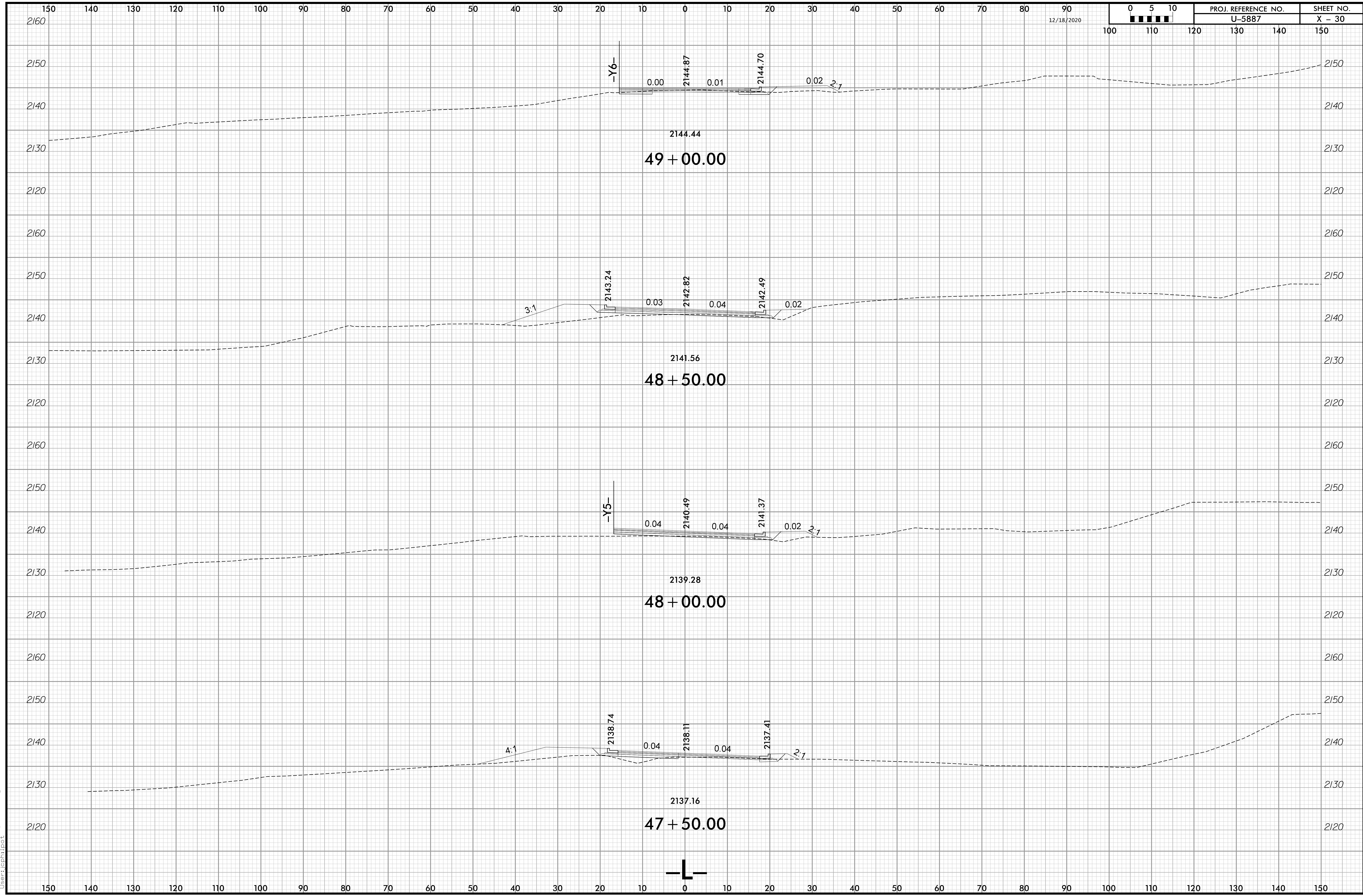

12/10/2020 12:20:48 PM
User: f10p11001

12/18/2020

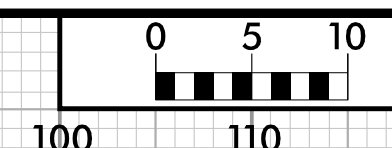

PROJ. REFERENCE NO.	SHEET NO.
U-5887	X - 31

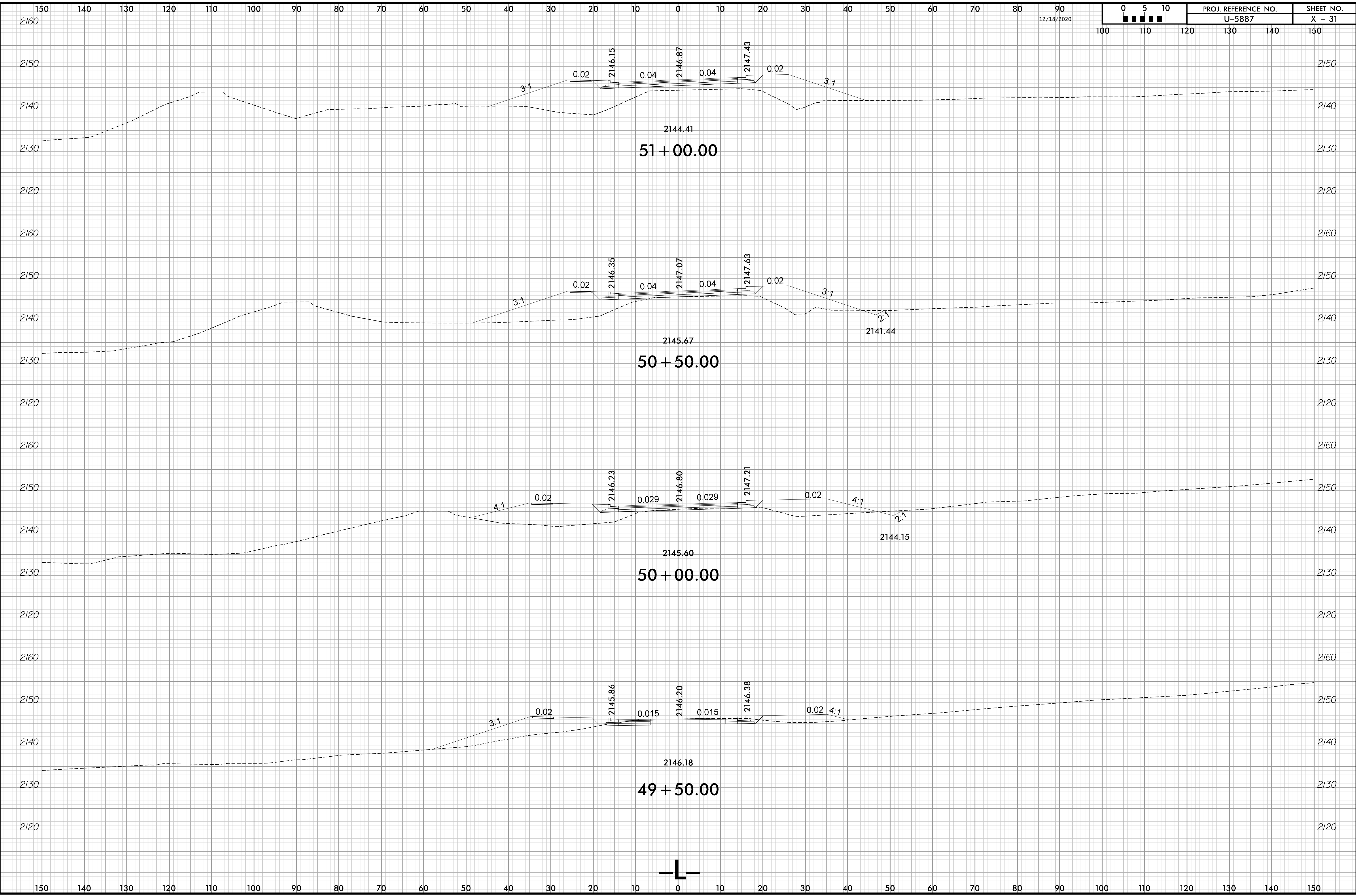

12/10/2020 12:20:48 PM
T:\Xsec\U-5887\rdy_XSc_L.dgn
User:alpbilpot

12/18/2020

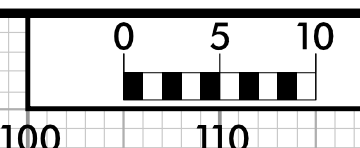

PROJ. REFERENCE NO.	SHEET NO.
U-5887	X - 32

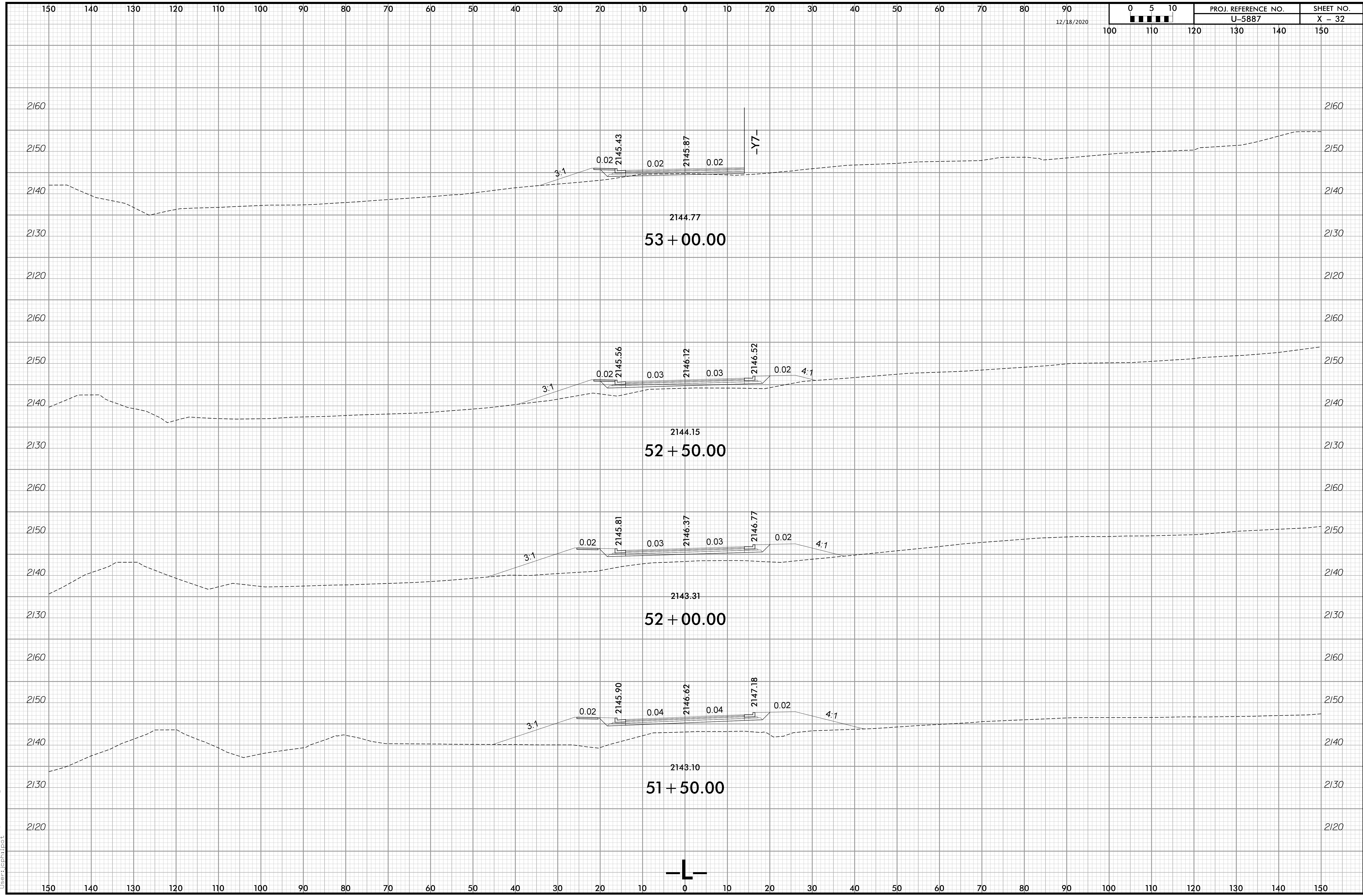

12/10/2020 12:20:48 PM
User: f10p111001

6/25/2020

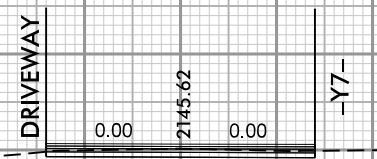
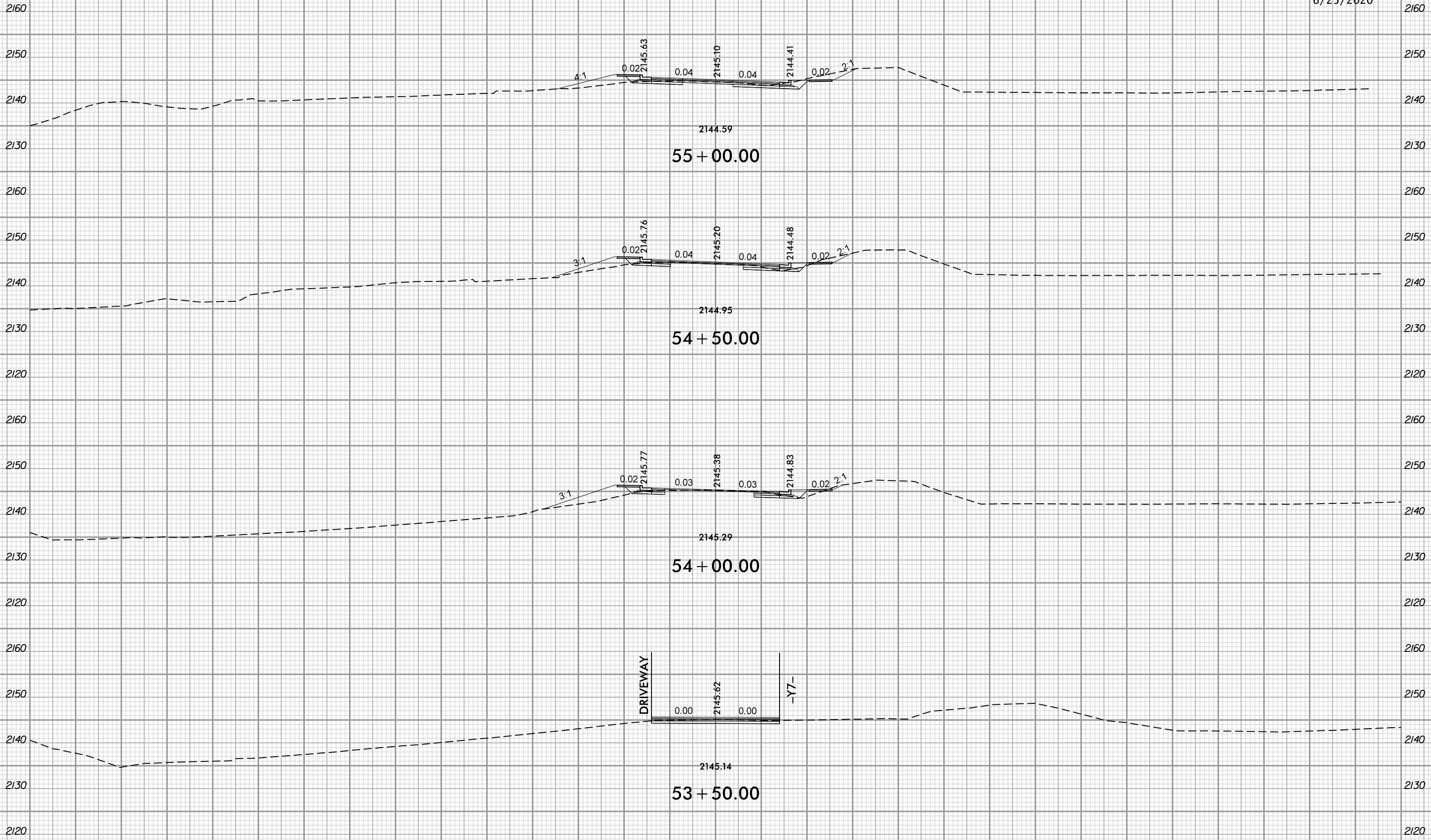

2145.14

53 + 50.00

6/9/2020 2:02:02 PM
User: r123456789

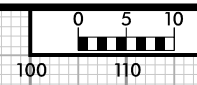

PROJ. REFERENCE NO.	SHEET NO.
U-5887	X - 34

6/25/2020

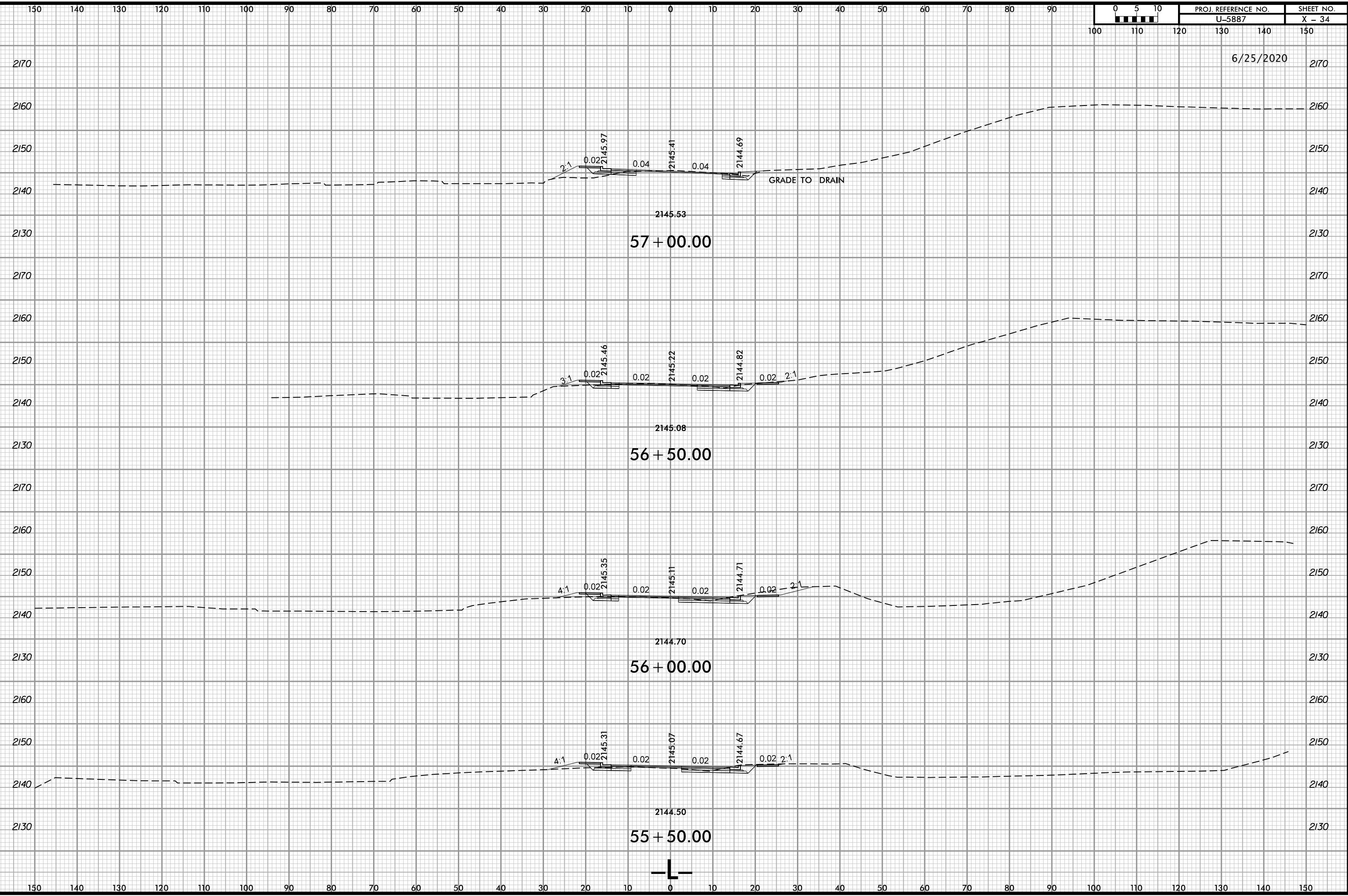

6/9/2020 2:02:02 PM
User: jcm11106

6/9/2020 2:02:02 PM
\\sac\U-5887_rdy_Xsc.L.dgn
User: rchm1106

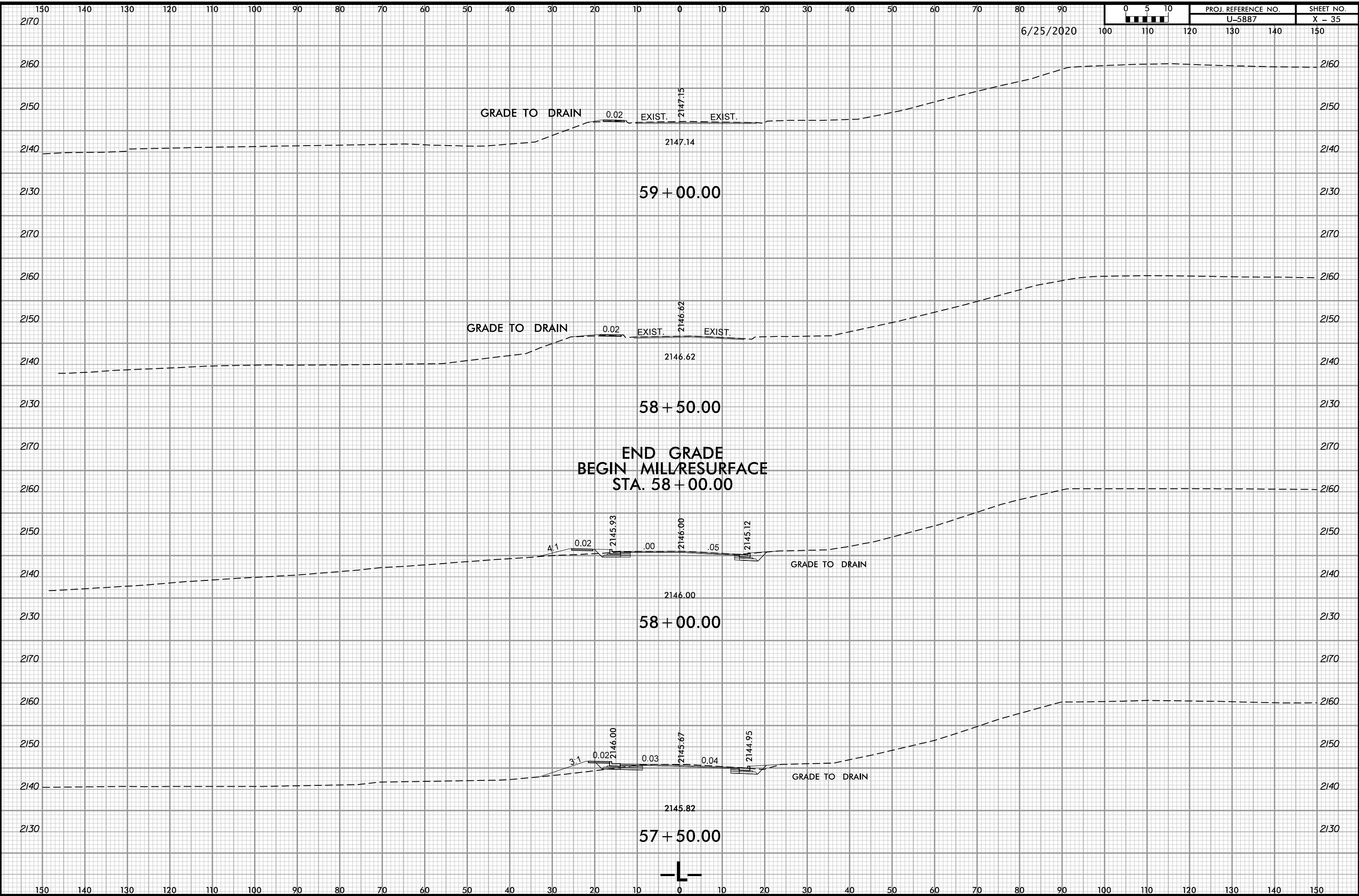

6/25/2020

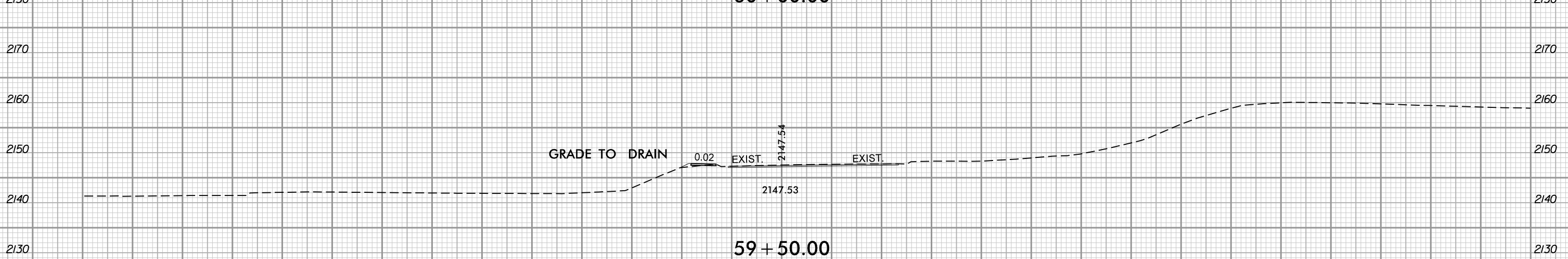
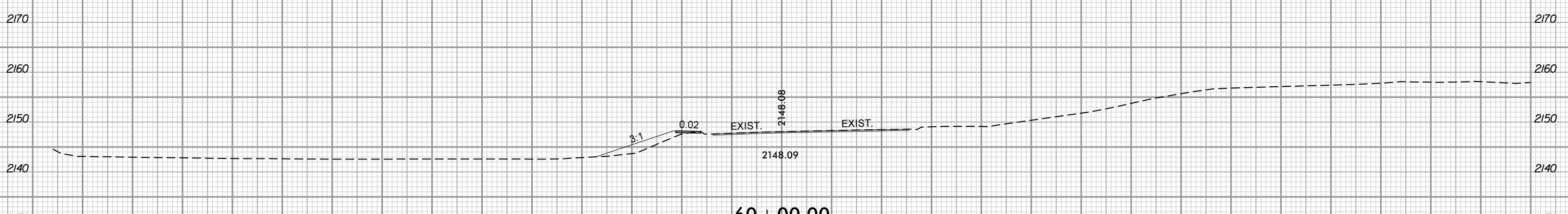
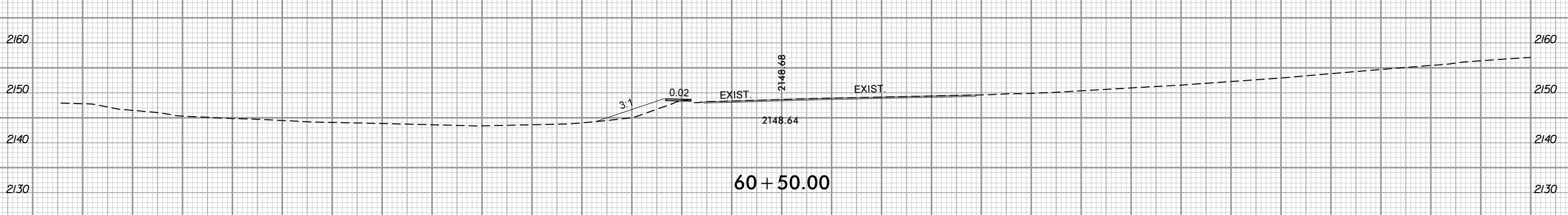
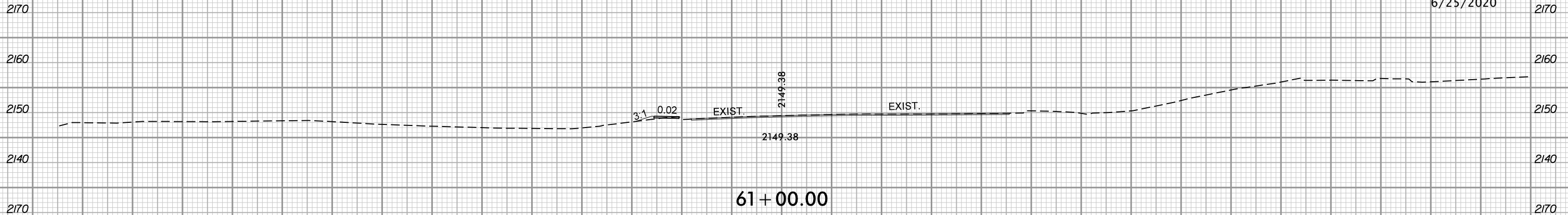

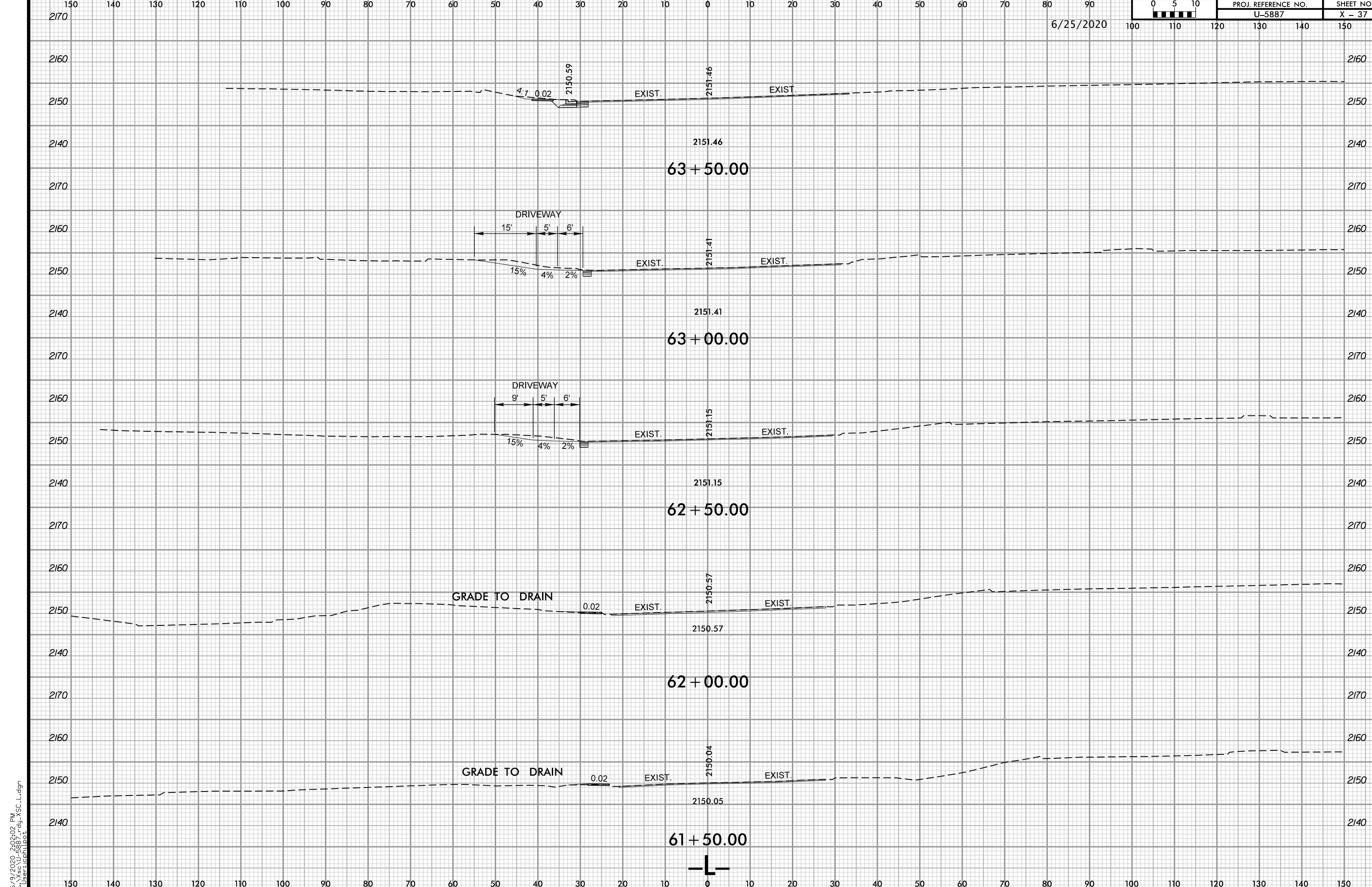

6/9/2020 2:02:02 PM
 \\Xsc\U-5887_rdy_Xsc.L.dgn
 User:ajcm1106

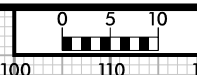
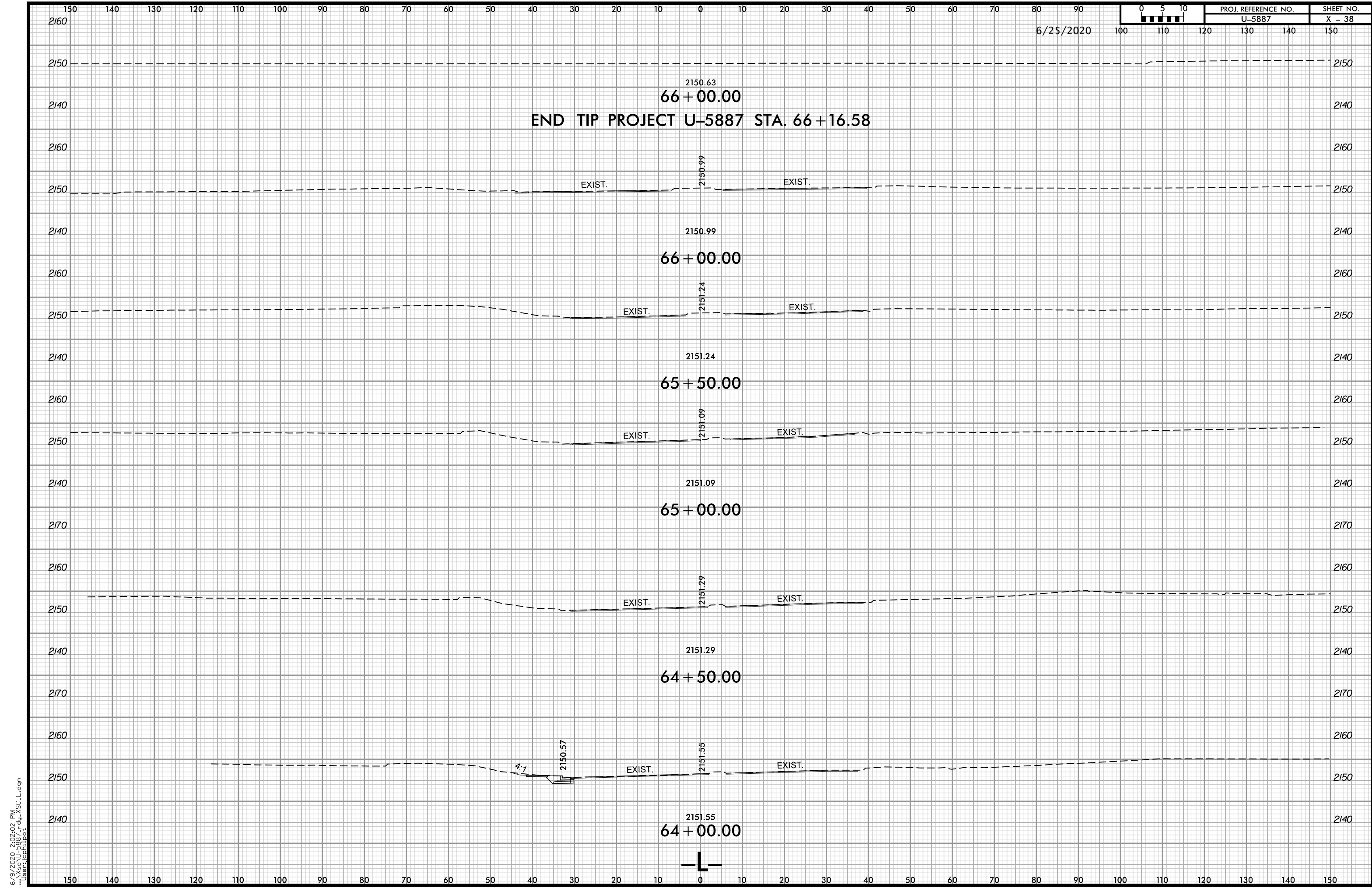

PROJ. REFERENCE NO.	SHEET NO.
U-5887	X - 38

6/25/2020

6/9/2020 2:02:02 PM
 ..\Xsec\U-5887_rdy_Xsc.L.dgn
 User: jcm1106

11/18/2020

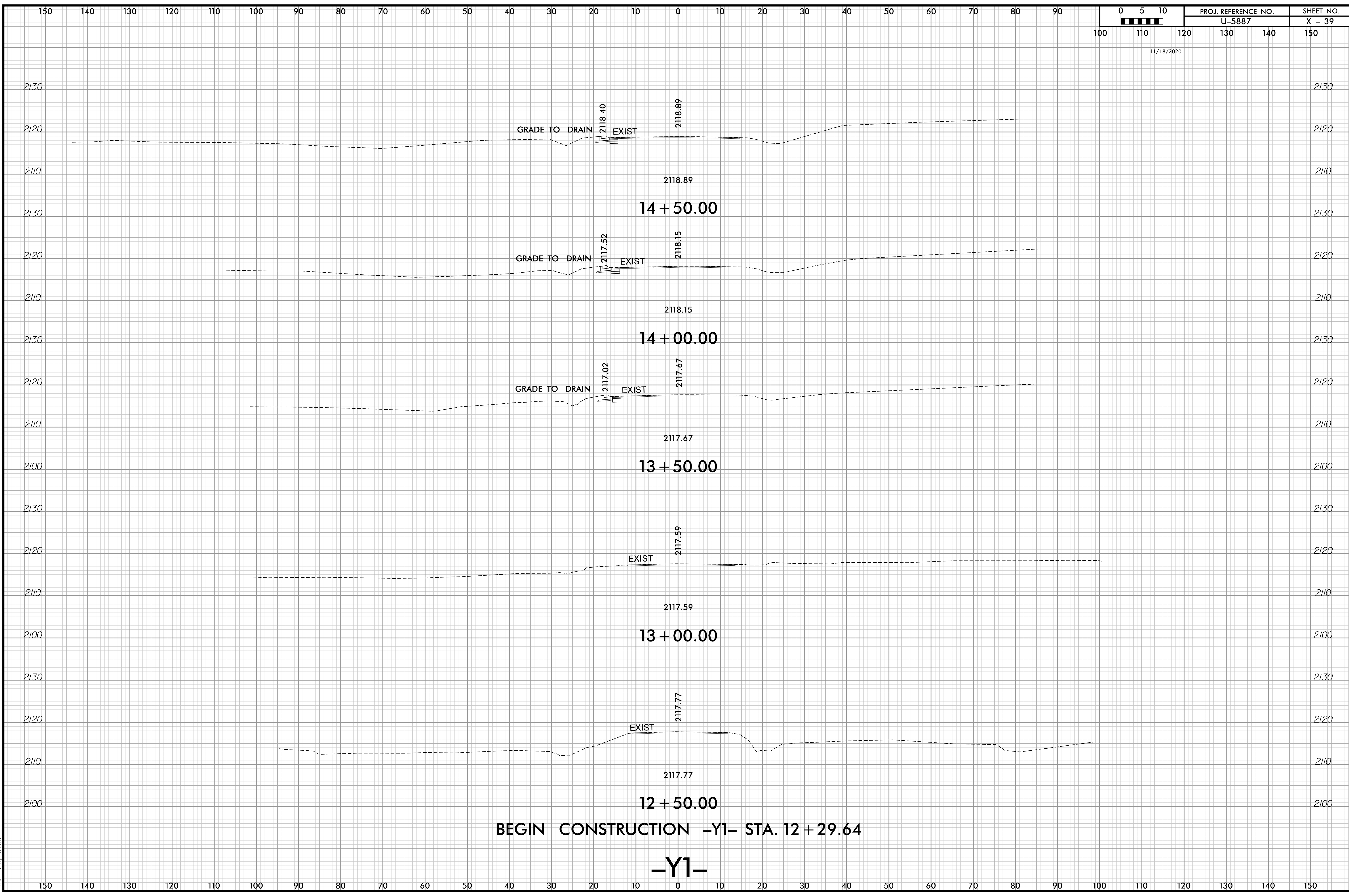

11/9/2020 9:08:04 AM
X:\Roadway\U-5887_XSC_Y.dgn
User:icphipot

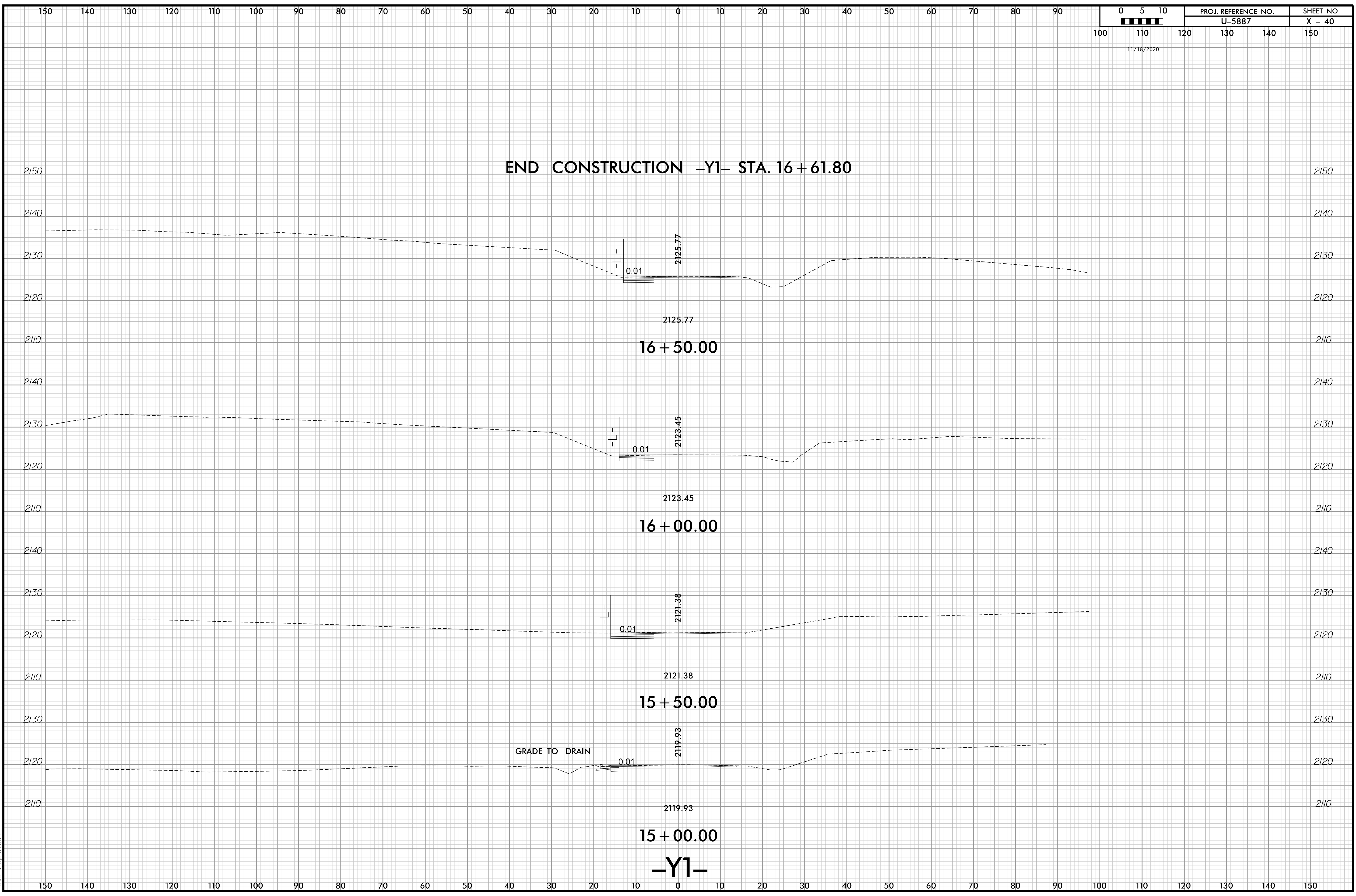

11/9/2020 9:46:11 AM
C:\Roadway\U-5887_XSC_Y.dgn
User:icphipot

11/18/2020

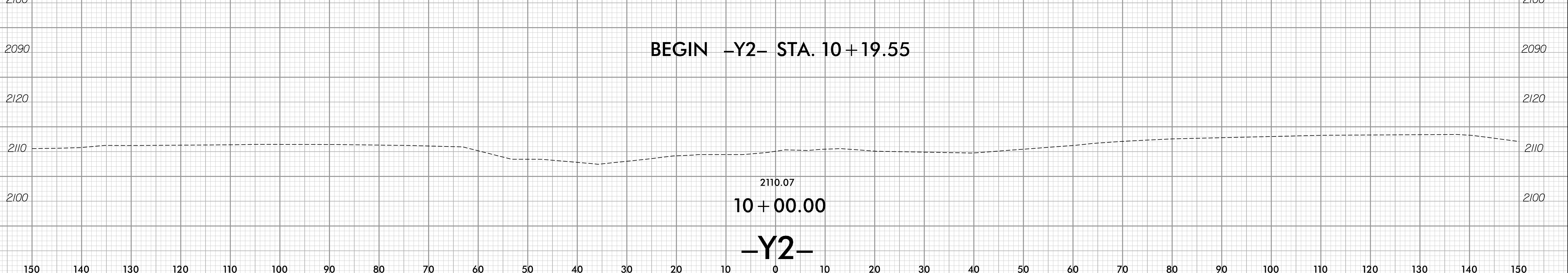
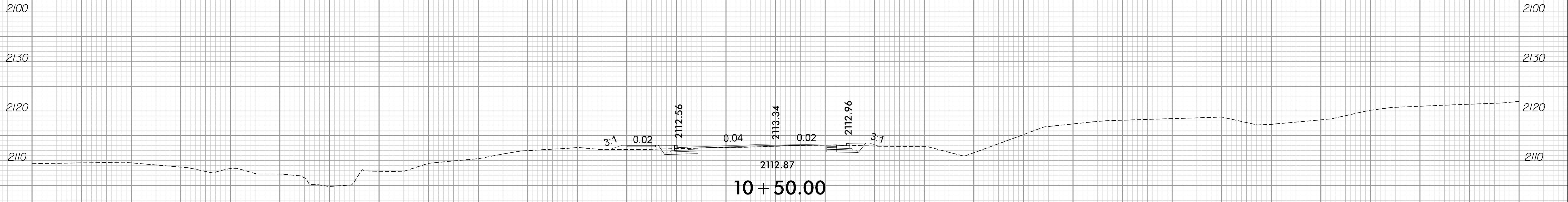
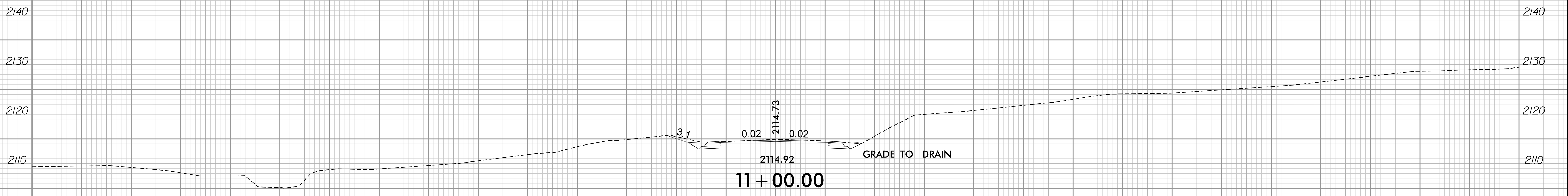
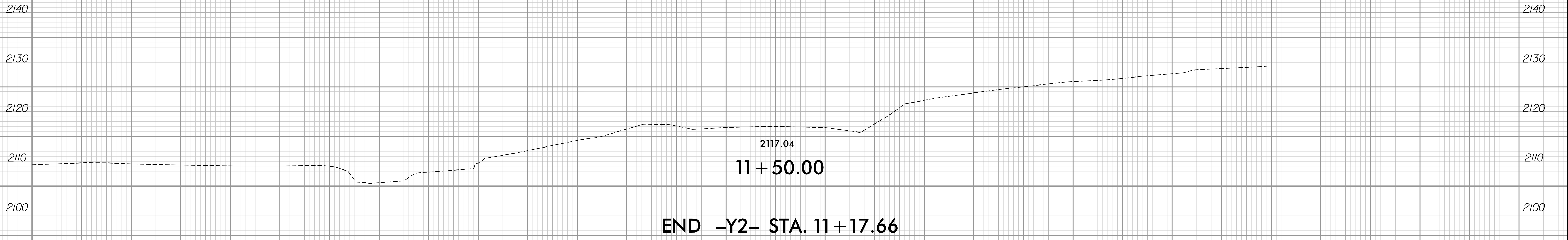

11/9/2020 9:46:11 AM
I:\Roadway\Xsc\U-5887_XSC_Y.dgn
User:alpb11

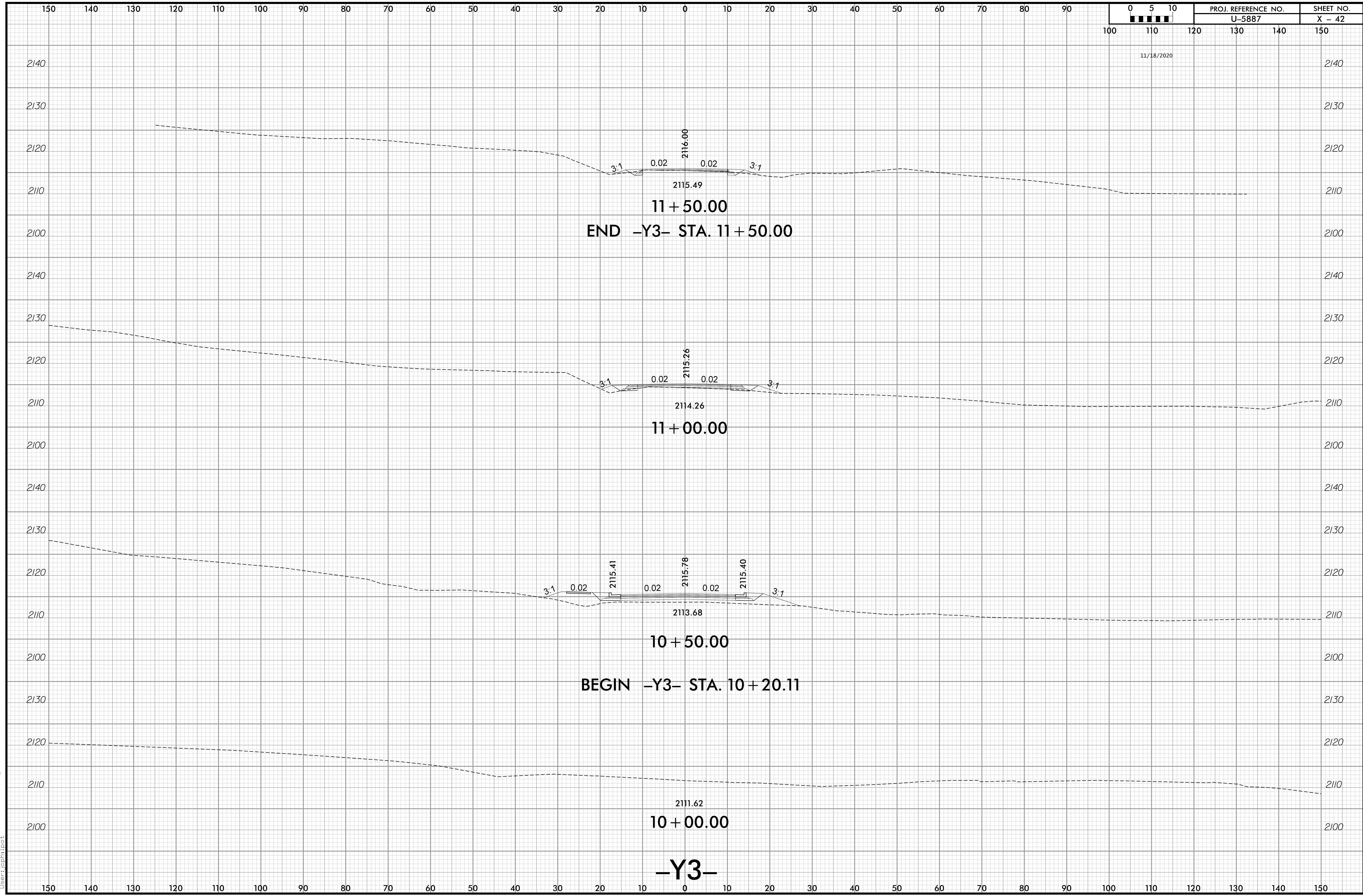

0	5	10	PROJ. REFERENCE NO.	SHEET NO.
100	110	120	U-5887	X - 42
130	140	150		

11/18/2020

11/9/2020 9:46:11 AM
I:\Roadway\Xsc\U-5887_XSC_Y.dgn
User:alpbill

11/18/2020

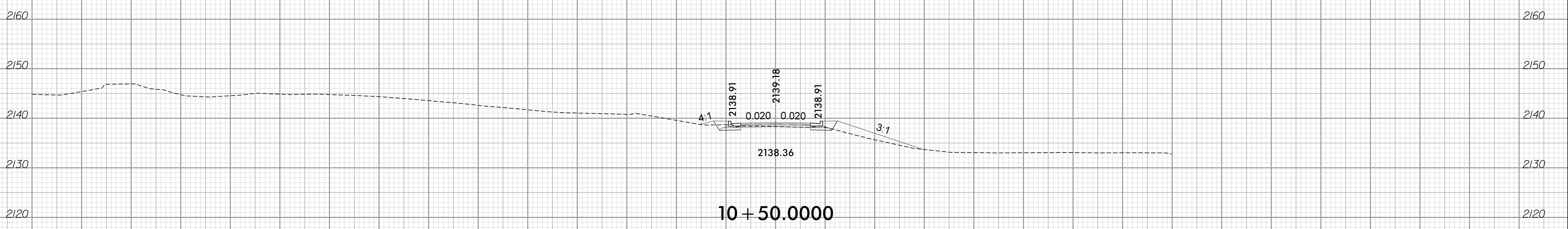
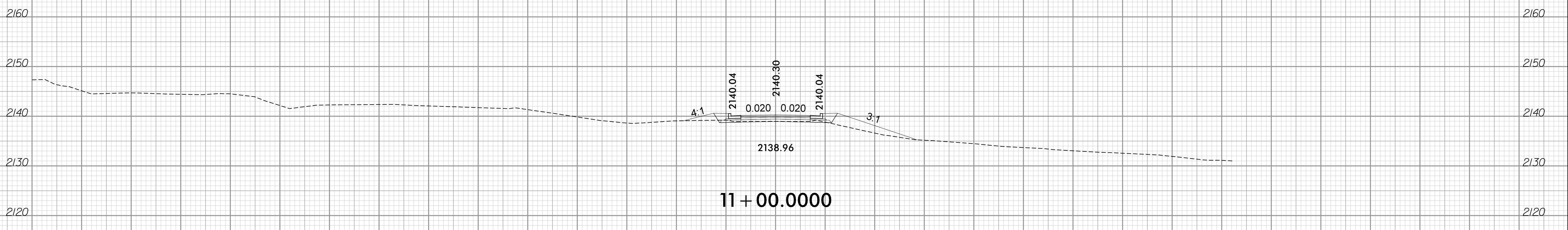

BEGIN CONSTRUCTION -Y5- STA. 10+21.94

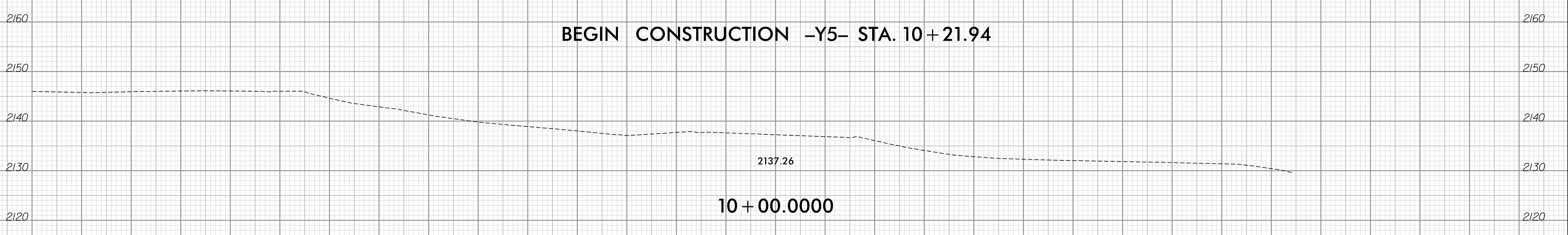

-Y5-

11/9/2020 10:02:23 AM
C:\Roadway\Xsc\U-5887_XSC_Y.dgn
User:alpbillpot

11/18/2020

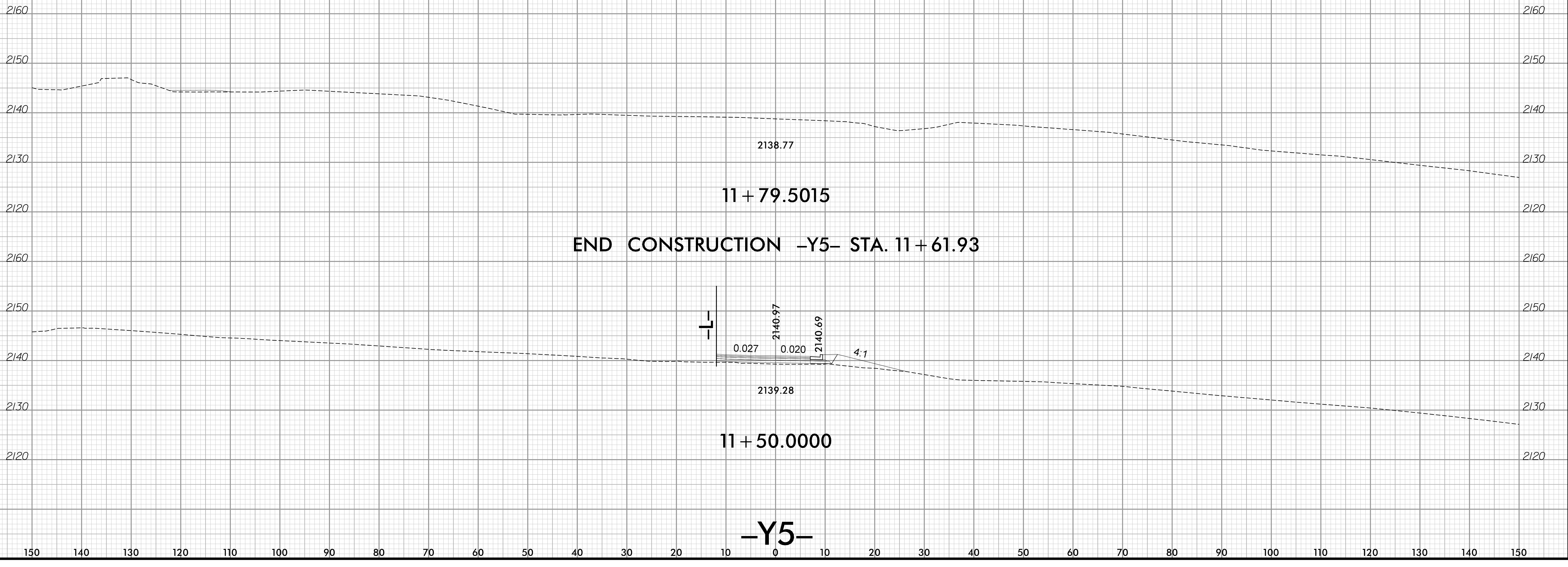

11/9/2020 10:17:20 AM
C:\Roadway\Xsc\U-5887_XSC_Y.dgn
User:alpbillpot

11/18/2020

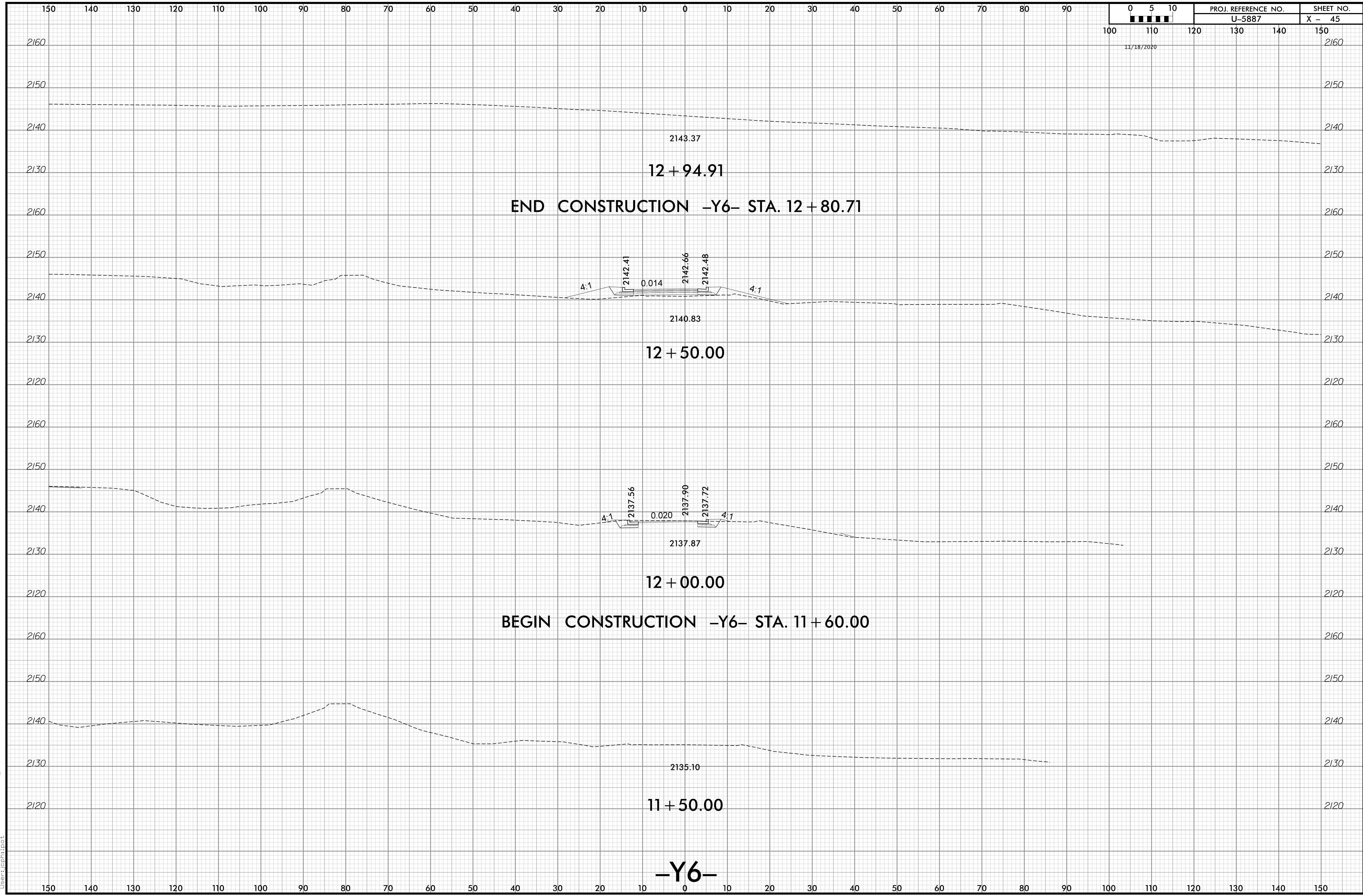

11/9/2020 10:17:20 AM
C:\Roadway\Xsc\U-5887_XSC_Y.dgn
User:alpbillpot

150 140 130 120 110 100 90 80 70 60 50 40 30 20 10 0 10 20 30 40 50 60 70 80 90

0 5 10 100 110 120 130 140 150	PROJ. REFERENCE NO.	SHEET NO.
	U-5887	X - 46

11/18/2020

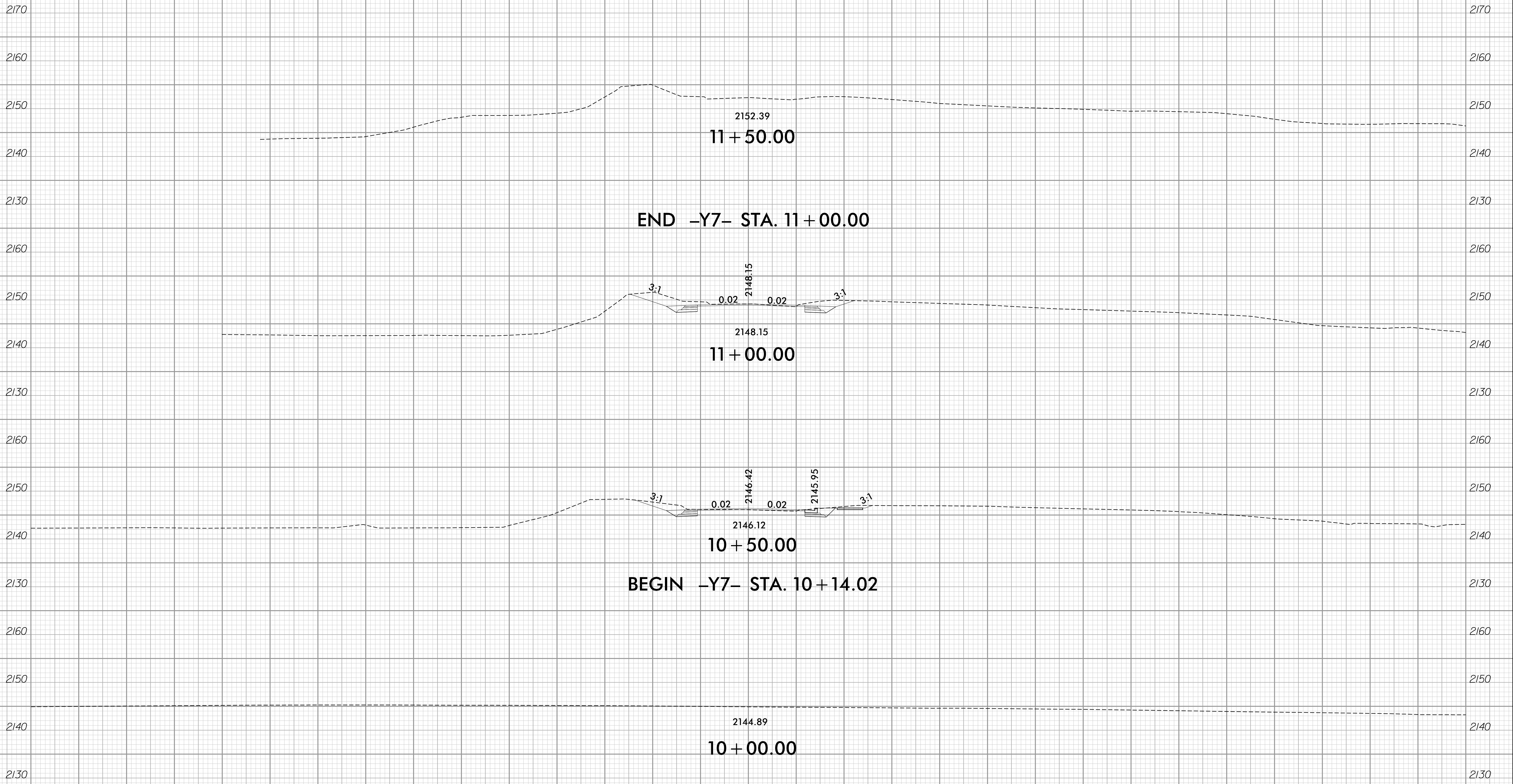

END -Y7- STA. 11+00.00

2152.39
11+50.00

2148.15
11+00.00

2146.12
10+50.00

BEGIN -Y7- STA. 10+14.02

2144.89
10+00.00

-Y7-

11/9/2020 10:17:20 AM
I:\Roadway\Xsc\U-5887_XSC_Y.dgn
User:alpbillpot

150 140 130 120 110 100 90 80 70 60 50 40 30 20 10 0 10 20 30 40 50 60 70 80 90 100 110 120 130 140 150

11/18/2020

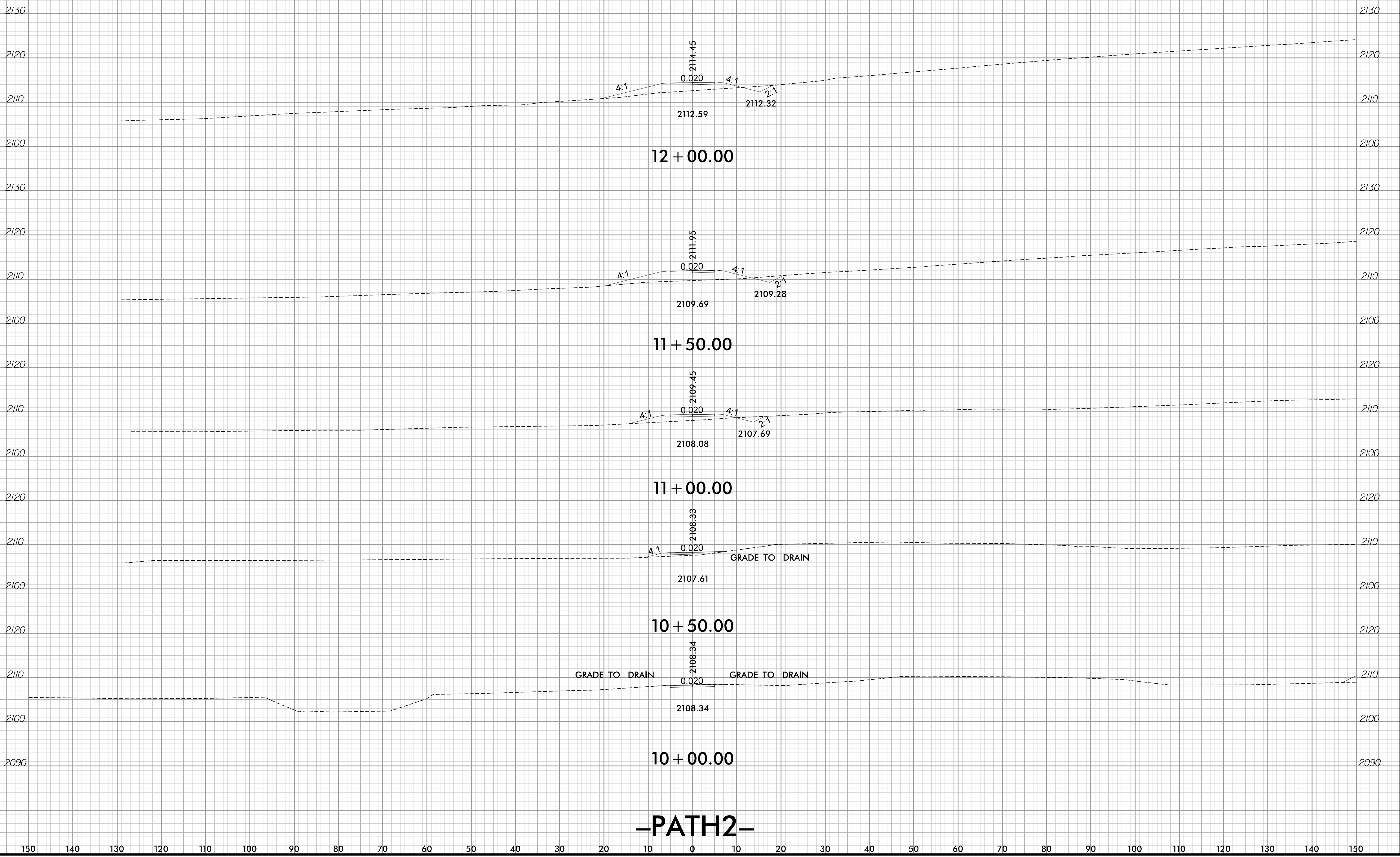

11/9/2020 11:54:43 AM
User: jphillips

11/18/2020

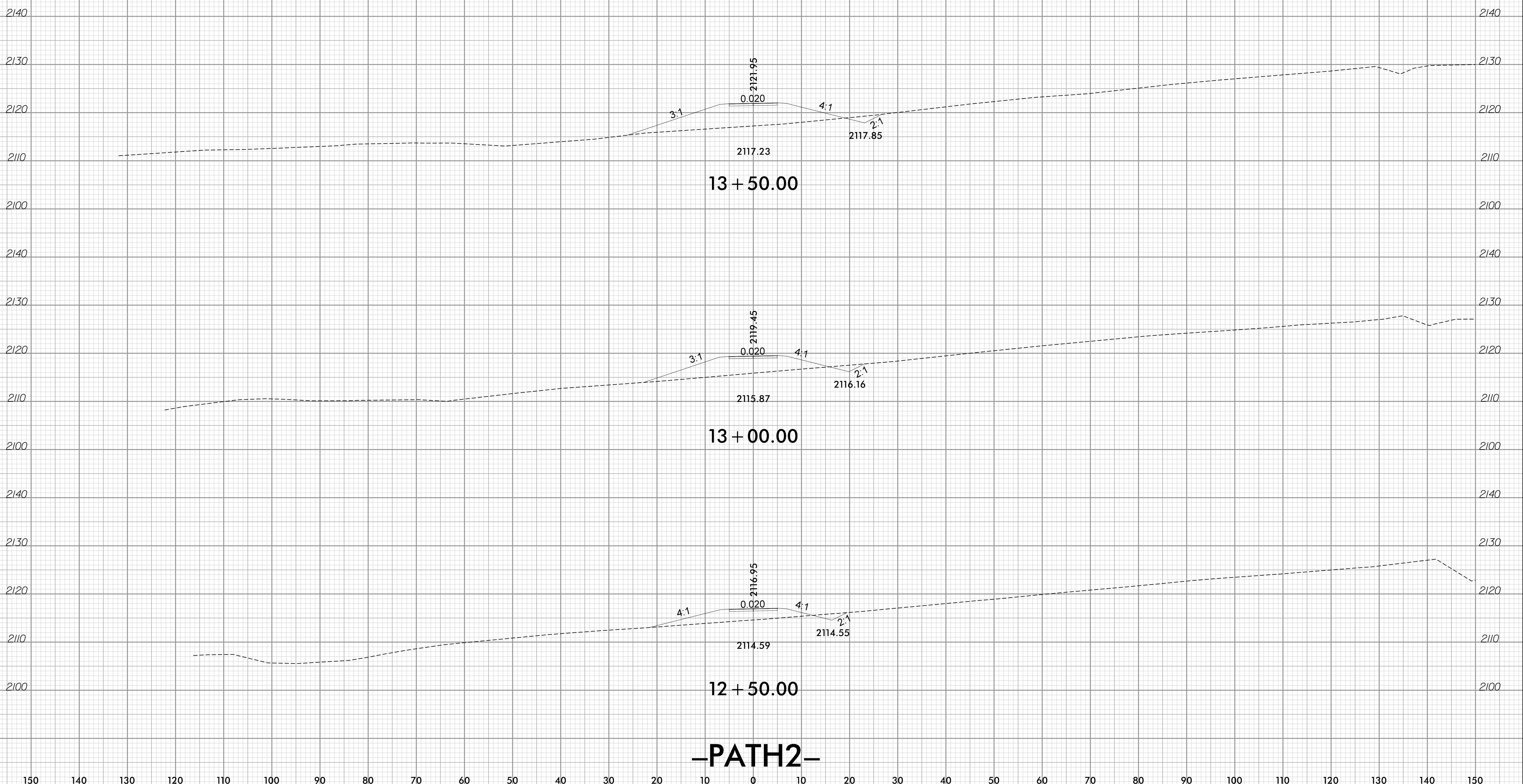

11/9/2020 11:54:43 AM
T:\Xsc\U-5887\rdy_XSC.L.dgn
User:alpb1102

11/18/2020

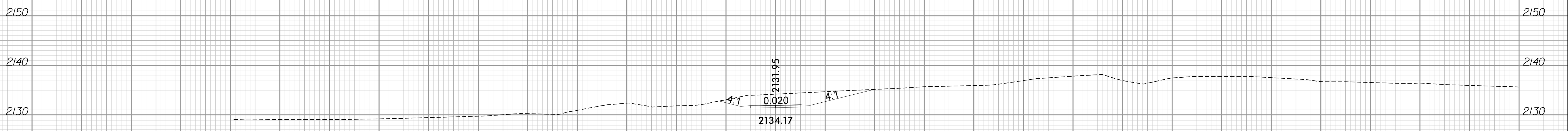

15 + 50.00

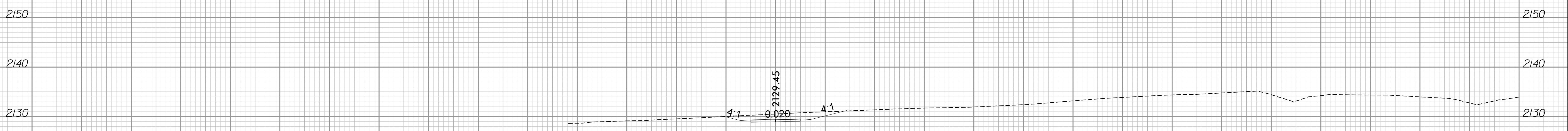

15 + 00.00

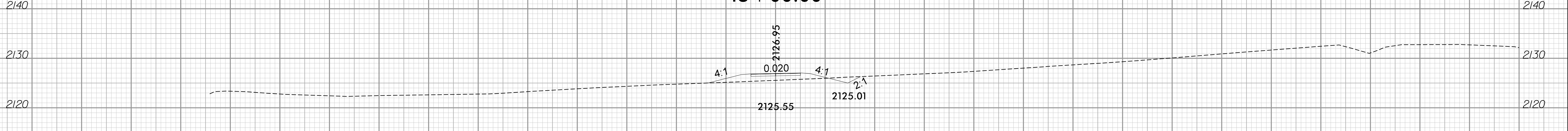

14 + 50.00

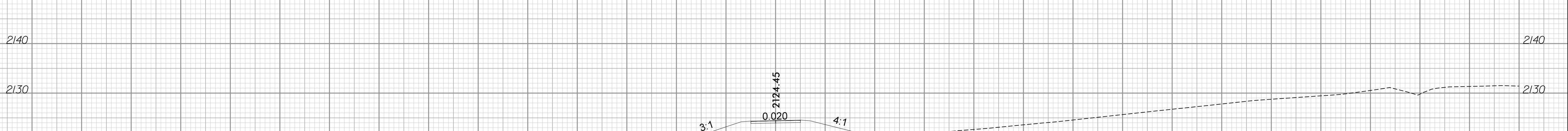

14 + 00.00

-PATH2-

11/9/2020 11:09:43 AM
User: jlp@h11001

11/18/2020

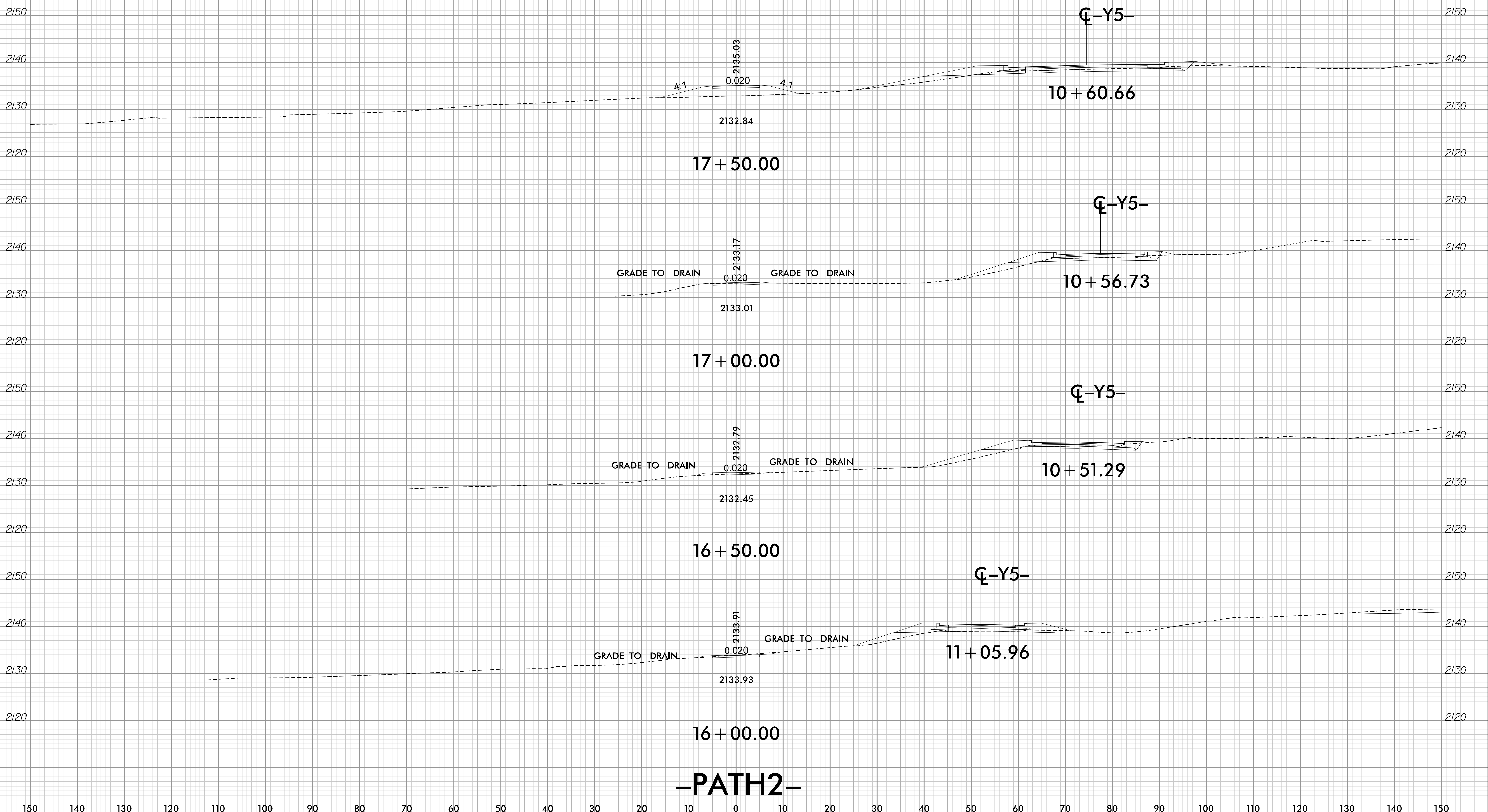

11/9/2020 11:09:43 AM
 User: jlp@h1100